

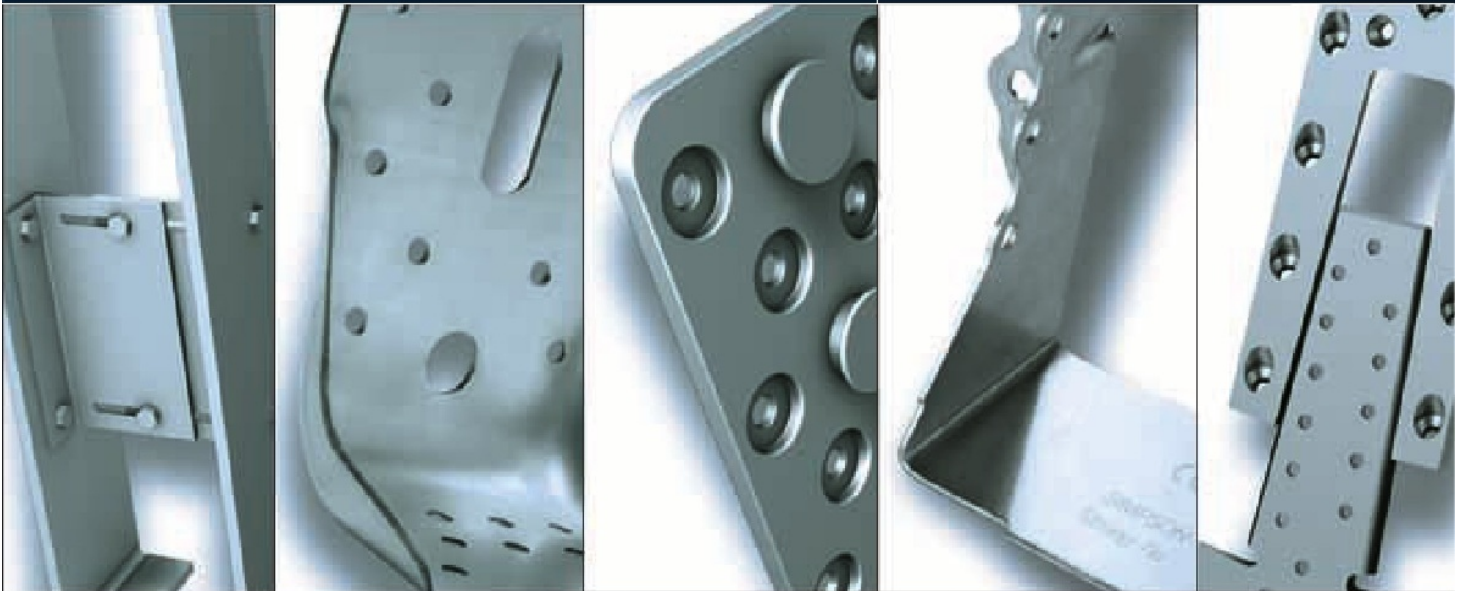

CENNÍK







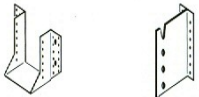

STREDNÁ EURÓPA

2012/2013



ME 2012/2013

www.strongtie.eu

	Name of chapter/Názvy kapitol	Chapter/Kapitola	Page/Strana
Content according to products Obsah podľa produktov			2a-2b
Content Obsah			3-7
	Angle bracket / Uholník	1	8-11
	Joist hanger / Papuča trámu Joist and support bracket/Nosič trámu	2	12-24
	Universal bracket/Univerzálna spojka Purlin anchor/Spojka krokva-vaznica	3	25-28
	Steel strap/Dierované pásy Windbracing strap/Zavetrovacie pásy	4	28-32
	Nail plates/Dierované platne; Truss clip/Kotva krokva-pomúrnica	5	33-36
	Cantilever bracket/Gerberova spojka	6	36-37
	Column shoe/Papuča podpery, <i>Noha podpery, Noha stípvov</i>	7	38-49
	HE-anchor/HE-kotva Profil anchor/Profilová kotva Connection profile/Pripojovacie profily	8	50
	Terrace clips/Terasové spony	9	51-52
	Stainless steel connector/Nerezové (antikorové) spojky	10	53
	Tension Tie/Ťahová kotva	11	54-56
	House and garden/Dom a záhrada	12	57-59
	Fasteners/Spojovací materiál	13	59-64

A	Page Strana
Angle Bracket	
AA (60280)	8
AB105	8
AB36125	11
AB70, AB90	8
AB55365	9
ABB40390	8
ABR (100, 105, 170, 70, 90, 9015, 9020)	9
AC35350	9
ADR (6035, 6090, 6191, 6292)	9
AE (116, 48, 76)	10
AF90265	9
AG (40312, 40314, 40412, 40414)	10
AH (16050, 19050, 29050, 9035)	56
AJ (60416, 80416, 99416)	10
AKR, ANP	10
ANPS	11
BNV33	11
CRE	57
E20/3	9
EBR	57
EC	57
EFIXR	57
FLVW	57
KNAG	11
RFC	57
SBV	59
ATF	
ATF	21
B	Page Strana
Band unwinder	
BANA	29
Batten nails	
SN	61
Bearing plate bracket	
SHLM, SHLS	35
Bozett	
BO	22
Bulldog	
C1, C2, C3, C4, C5	62
C	Page Strana
Case column	
BH54	38
CFR	
CF-R	59

CNA (connector nails)	
CNA	60
Column shoe	
CMR, CPB, CPS	38
JDB, JGB, JGS	49
PA, PB, PBE, PBK	39
PBR, PCR	58
PDKB, PDKS	40, 58
PDL	47, 58
PDS	49
PGS	40
PI, PIL	41
PIS, PISB, PISBMAXI, PISMAXI	42
PJIB, PJIS, PJPB, PJBS	42-43
PL, PLB, PLS,	43-44
PP, PPA, PPB, PPD	44-46
PPL, PPRC, PPS	44-45
PPU	47,58
PT	58
PTB	47,58
PU	48
PVD, PVDB, PVIB, PVI, PDB	49
Concrete angle	
ABL, ABS	8
Concrete anchor	
BETA	54
Concrete screw	
SBS	61
Connecting wall strip	
C2KS	50
CP fence bracket	
CP	58
CSA connector screws	
CSA	60
D	Page Strana
DLV batten connector	
DLV	28
E	Page Strana
E-jot screw	
JT2	55
EL top connector	
EL - EL-S	20
ET joist end grain connector	
ETB	20
EWP - form	
ITSE, USE, LSSU, LSSUI, LSTA	24

F	Page Strana
FLV flat nail plates	
FLV	34,59
G	Page Strana
GEKA press-in shear plate	
C10, C11	63
H	Page Strana
HE- profile anchor	
HE	50
Handrails console	
SRC, SRD, SRR	59
I	Page Strana
Installation templates	
FRATF, MO	23
J	Page Strana
JANE@TU, JANE@TUS	
TU, TUS	19
JANEBO@	
JANEBO@, JHD, JHH	21
Joisthanger	
BSD, BSDI, BSI, BSIL, BSN2P, BSN, BSS, GSE, SBE, SBG	12-18
Joist end support bracket	
BT4, BTN, BTALU	19
K	Page Strana
KOLLIBRODD fasteners	
KOL	64
M	Page Strana
Milling an nstallation template	
BTBS, ETPP	23, 38
N	Page Strana
Nail plates and nail strip	
NP, MP	33-35
P	Page Strana
Purlin anchor	
SPF	26
Plates for U-shoe	
PUA/B	48
Post shoe, post support shoe, post support	
PPH, PPHB, PPJ, PH	41,58

Practillet® steel strap	
FBAR, FBPR	29,59
Profile anchor	
PROFA	50
Purlin anchor	
PFE, PFU	26,27
S	Page Strana
Splitring	
B1, A1	63
SPAX® screw	
SPAX	59
Steel dowels	
STD	61
Stair case angles	
TA	57
T	Page Strana
Tension strap	
BANSTR, BANSTRS	30
Tension tie	
AH, HD, HD2P, LTT, HTT	54-56
Terrace connectors, Terrace clip	
DBCS, DBT1Z, HDMS, EB-TY	51-52
Truss shoe, Truss clip	
GER, SHB, SHH, SFH, SFHM, SFHS, SFM, SFN	35-37
T-Profile	
TALU	22
Top batten	
TOP, TOL	27
U	Page Strana
Universal bracket	
UNI	25
U-Washer	
US	55, 64
U-shoe	
PUA	48
W	Page Strana
Windbracing	
BAN, BN, BNW	28, 30-32

Items number NEW Číslo položky nové	Item description / Popis položky	Chapter Kapitola	Page Strana
AA60280	Angle bracket 60280 • Uholník 60280	1	8
AB105	Angle bracket 105 o/R • Uholník 105 o/R	1	8
AB36125 u. 6983	Angle bracket • Uholník	1	11
AB70	Angle bracket 70 o/R • Uholník 70 o/R	1	8
AB90	Angle bracket 90 o/R • Uholník 90 o/R	1	8
ABB40390	Angle bracket 40390 • Uholník 40390	1	8
ABL	Concrete angle P • Uholník do betónu P	1	8
ABR100	Angle bracket • Uholník	1	9
ABR105	Angle bracket 105 • Uholník 105	1	9
ABR170	Angle bracket 170 • Uholník 170	1	9
ABR70	Angle bracket 70 m/R • Uholník 70 m/R	1	9
ABR90	Angle bracket 90 • Uholník 90	1	9
ABR9015	Angle bracket 9015 • Uholník 9015	1	9
ABR9020	Angle bracket 9020 • Uholník 9020	1	9
ABS	Concrete angle S • Uholník do betónu S	1	8
AB55365	Angle bracket 55365 • Uholník 55365	1	9
AC35350	Angle bracket AC35350 • Uholník AC35350	1	9
ADR6035	Angle bracket 6035 • Uholník 6035	1	9
ADR6090	Angle bracket 6090 • Uholník 6090	1	9
ADR6191	Angle bracket 6191 • Uholník 6191	1	9
ADR6292	Angle bracket 6292 • Uholník 6292	1	9
AE116	Angle bracket 90x48x3,0x116 • Uholník 90x48x3,0x116	1	10
AE48	Angle bracket 90x48x3,0x48 • Uholník 90x48x3,0x48	1	10
AE76	Angle bracket 90x48x3,0x76 • Uholník 90x48x3,0x76	1	10
AF90265	Angle bracket 90265 • Uholník 90265	1	9
AG40312	Angle bracket 40312 • Uholník 40312	1	10
AG40314	Angle bracket 40314 • Uholník 40314	1	10
AG40412	Angle bracket 40412 • Uholník 40412	1	10
AG40414	Angle bracket 40414 • Uholník 40414	1	10
AH	Tension tie • Ťahová kotva	11	56
AH16050	Angle bracket 160x50x3,0x40 (Tension tie) • Uholník 160x50x3,0x40 (Ťahová kotva)	11	56
AH19050	Angle bracket 190x50x2,0x40 (Tension tie) • Uholník 190x50x2,0x40 (Ťahová kotva)	11	56
AH29050	Angle bracket 290x50x2,0x40 (Tension tie) • Uholník 290x50x2,0x40 (Ťahová kotva)	11	56
AH9035	Angle bracket 90x35x2,5x40 (Tension tie) • Uholník 90x35x2,5x40 (Ťahová kotva)	11	56
AJ60416	Angle bracket 60416 • Uholník 60416	1	10
AJ80416	Angle bracket 80416 • Uholník 80416	1	10
AJ99416	Angle bracket 99416 • Uholník 99416	1	10
AKR	Angle bracket KR perforated metal • Uholníková spojka KR	1	10
ANP	Angle bracket from perforated plates (2,5 mm) • Uholníková spojka z dierovaného plechu(2,5mm)	1	10
ANPS	Angle bracket from perforated plates (2 mm) • Uholníková spojka z dierovaného plechu(2mm)	1	11
ATF	ATF	2	21

Items number NEW Číslo položky nové	Item description / Popis položky	Chapter Kapitola	Page Strana
B1, A1	Splitring (APPEL) • Appel záchytky, jednostranné/obojsstranné	13	63
BAN	Windbracing strap • Dierované pásy	4	28
BANA	Band unwinder • Odvíjač zavetrovacích pásov s vyrovnávačom	4	29
BANSTR	Tension strap • Šponovák	4	30
BANSTRS	Tension strap S® • Šponovák S®	4	30
BETA	Concrete anchor • Kotva do betónu	11	54
BH54	Column shoe • Noha podpery	7	38
BN	Windbracing system • Zavetrovací systém	4	30, 31
BNV33	Angle bracket 33x61x1,5x180 • Uholník 33x61x1,5x180	1	11
BNW	Windbracing brackets • Pripojky zavetrenia	4	32
BO	Bozett	2	22
BSD	Joisthanger with perforated plates • Papuča trámu s dierovaným plechom	2	16
BSDI	Joisthanger with perforated plates type • Papuča trámu s dierovaným plechom typ	2	16
BSI	Joisthanger • Papuča trámu	2	13
BSIL	Joisthanger type L • Papuča trámu typ L	2	17
BSN	Joisthanger • Papuča trámu	2	12
BSN2P	Joisthanger 2-parts • Papuča trámu 2-dielna	2	17
BSS	Joisthanger S • Papuča trámu S	2	18
BT4	Joist and support bracket 4-rows • Nosič trámu 4-radový	2	19
BTALU	ALU joist and support bracket • ALU nosič trámu	2	19
BTBS	Milling and installation template for EL • Frézovacia a montážna šablona pre nosiče trámov	2	23
BTN	Joist and support bracket • Nosič trámu	2	19
C1, C5, C3	Bulldog double sided tothing • Bulldog záchytky, obojsstranne ozubené	13	62
C10, C11	GEKA press-in shear plate • GEKA záchytky, jednostranne/obojsstranne ozubené	13	63
C2, C4	Bulldog one sided tothing • Bulldog jednostranne ozubené	13	62
C2KS	Connecting wall strip • Pripojovací pás do steny	8	50
CF-R	CFR angle bracket • CFR Uholníky	12	59
CMR	Column shoe CMR • Noha podpery CMR	7	38
CNA	CNA connector nails • CNA kotviace klince	13	60
CP	CP fence bracket • CP plotové kovanie	12	58
CPB	Column shoe CPB • Noha podpery CPB	7	38
CPS	Column shoe CPS • Noha podpery CPS	7	38
CRE	Angle bracket CRE • Uholník CRE	12	57
CSA	CSA connector screws • CSA skrutky	13	60
DLV	DLV batten connector • DLV spojky strešných lát	3	28
DBCS	Terrace connectors • Terasová spojka	9	51
EB-TY®	Terrace connectors • Terasová spojka	9	52
DBT1Z	Terrace clip • Terasový klip	9	51
E20/3	Angle bracket E20/3 • Uholník E20/3	1	9
EBR	Angle bracket for rounded timber • Gufatinová spojka	12	57
EC	Angle bracket (stand) • Uholník (stojkový)	12	57
EFIXR	Angle bracket EFIXR • Uholník EFIXR	12	57
EL - EL-S	EL top connector • EL skrytá papuča trámu	2	20
ETB	ET joist end grain connector • Skrytá trémová spojka ET	2	20

Items number NEW Číslo položky nové	Item description / Popis položky	Chapter Kapitola	Page Strana
ETTP	Milling and installation template for ET • Frézovacia a montážna šablóna pre nosiče trámov ET	2	23
FBAR	Practillet® steel strap • Practillet® dierované pásy	4, 12	29, 59
FBPR	Practillet® steel strap • Practillet® dierované pásy	4, 12	29, 59
FLV	FLV flat nail plates • FLV ploché spojky	5, 12	34, 59
FLVW	Angle bracket • Uholník	12	57
FRATF	Installation templates for ATF • Montážna šablóna pre ATF	2	23
GER	Truss shoe • Osedlanie krokiev a Gerberove spojky	6	36, 37
GSE	Joisthanger • Papuča trámu	2	18
HD	Tension tie • Ťahová kotva	11	54
HD2P	Tension tie included washer • Ťahová kotva vrátane podložky	11	55
HDMS	Terrace clip • Terasový klip	9	51
HE	HE-Profile anchor • HE-profilová kotva	8	50
HTT	Tension tie • Ťahová kotva	11	55
ITSE - USE	EWP-Form • EWP-tvarovky	2	24
JDB	Column shoe JDB • Noha podpery JDB	7	49
JGB	Column shoe JGB • Noha podpery JGB	7	49
JGS	Column shoe JGS • Noha podpery JGS	7	49
JHD - JHH	JANEBO®	2	21
JT2	E-Jot screw • E-jot šrób	11	55
KNAG	Angle bracket KNAG • Uholník KNAG	1	11
KOL	KOLLIBRODD fasteners • KOLLIBROD spojka	13	64
LSSU, LSSUI, LSTA	EWP-Form • EWP-tvarovky	2	24
LTT	Tension tie • Ťahová kotva	11	55
MO	Installation templates • Instalačná šablóna	2	23
MP	MP nail plates • MP styčnikove plechy	5	35
NP	Nail plates and nail plates strip • Dierované plechy a pásy	5	33, 34
PA	Column shoe PA • Noha podpery PA	7	39
PB	Column shoe PB • Noha podpery PB	7	39
PBE	Column shoe BL • Noha podpery BL	7	39
PBK	Column shoe BK • Noha podpery BK	7	39
PBR NEU	Column shoe PBR24/50G • Noha podpery PBR24/50G	12	58
PCR NEU	Column shoe PCR24/50G • Noha podpery PCR24/50G	12	58
PDB	Column shoe DB • Noha podpery DB	7	49
PDKB	Column shoe DKB • Noha podpery DKB	7	40
PDKS	Column shoe DKS • Noha podpery DKS	7	40
PDL	Column shoe DL • Noha stĺpov DL	7	47
PDS	Column shoe DS • Noha podpery DS	7	49
PFE	Purlin anchor E • Spojka vaznica-krokvá E	3	26
PFU	Purlin anchor U • Spojka vaznica-krokvá U	3	27
PGS	Column shoe GS • Noha podpery GS	7	40
PH	Post support • Držiak stĺpa	7	41
PI	Column shoe • Noha podpery	7	41
PIL	Column shoe L • Noha podpery L	7	41
PIS	Column shoe S • Noha podpery S	7	42

Items number NEW Číslo položky nové	Item description / Popis položky	Chapter Kapitola	Page Strana
PISB	Column shoe SB • Noha podpery SB	7	42
PISBMAXI	Column shoe SB MAXI • Noha podpery SB MAXI	7	42
PISMAXI	Column shoe S MAXI • Noha podpery S MAXI	7	42
PJIB	Column shoe JIB • Noha podpery JIB	7	42
PJIS	Column shoe JIS • Noha podpery JIS	7	42
PJPB	Column shoe JPB • Noha podpery JPB	7	43
PJBS	Column shoe JBS • Noha podpery JBS	7	43
PL	Column shoe PL • Noha podpery PL	7	43
PLB	Column shoe PLB • Noha stĺpov PLB	7	44
PLS	Column shoe PLS • Noha stĺpov PLS	7	44
PP	Column shoe P • Papuča podpery P	7	46
PPA	Column shoe PPA • Noha podpery PPA	7	44
PPB	Column shoe PB • Noha podpery PB	7	45
PPD	Column shoe D • Papuča podpery D	7	46
PPH	Post support shoe H • Kotva stĺpa H	12	58
PPHB	Post support shoe HB • Kotva stĺpa HB	12	58
PPJ	Post shoe PJ • Narážacia kotva stĺpa PJ	12	58
PPL	Column shoe PL • Papuča podpery PL	7	46
PPRC	Column shoe PPRC • Noha podpery PPRC	7	44
PPS	Column shoe PS • Noha podpery PS	7	45
PPU	Column shoe DK • Noha stĺpov DK	7	47
PROFA	Profile anchor • Profilová kotva	8	50
PT	Column shoe PT30G • Noha podpery PT30G	12	58
PTB	Column shoe TB • Noha stĺpov TB	7	47
PU	Column shoe U • Noha stĺpov U	7	48
PUA	Column shoe U • Noha stĺpov U	7	48
PUA/B	Column shoe U • Noha stĺpov U	7	48
PVD	Column shoe Vario D • Noha podpery Vario D	7	49
PVDB	Column shoe Vario D • Noha podpery Vario D	7	49
PVIB	Column shoe Vario B • Noha podpery Vario B	7	49
PVI	Column shoe Vario • Noha podpery Vario	7	49
RFC	RFC angle bracket/ • RFC Uholník	12	57
SBE	Joisthanger SBE • Papuča trámu SBE	2	14
SBG	Joisthanger SBG • Papuča trámu SBG	2	15
SBS	Concrete screw SBS • Skrutka do betónu SBS	13	61
SBV	SBV angle bracket • SBV konzolový uholník	12	59
SFH	Truss clip H • Osedlanie krokiev H	5	35
SFHM	Truss clip HM • Osedlanie krokiev HM	5	35
SFHS	Truss clip HS • Osedlanie krokiev HS	5	35
SFM	Truss clip MAXI • Osedlanie krokiev MAX	5	35
SFN	Truss clip Normal SFN • Osedlanie krokiev Normal SFN	5	35
SHB	Truss shoe B • Papuča krokvy B	5	36
SHH	Truss shoe H • Papuča krokvy H	5	36
SHLM	Bearing plate bracket LM • Držiak prahu LM	5	35
SHLS	Bearing plate bracket LS • Držiak prahu LS	5	35

Items number NEW Číslo položky nové	Item description / Popis položky	Chapter Kapitola	Page Strana
SN	Batten nails • Krokrové klínce	13	61
SPAX	SPAX® screw • SPAX®-skrutka	13	59
SPF	Purlin anchor • Spojka vaznica-krokva	3	26
SRC, SRD, SRR	Handrails console • Konzola zábradlia	12	59
STD	Steel dowels • Kolíky	13	61
TA	Stair case angles TA • Uholník schodový TA	12	57
TALU	T-Profile ALU • T-profil ALU	2	22
TOP / TOL	Top batten bracket • Držiak hrebeňovej laty	3	27
TU	JANE@TU • Nosič trámu JANE@TU	2	19
TUS	JANE@TUS • Nosič trámu JANE@TUS	2	19
UNI	Universal bracket • Univerzálna spojka	3	25
US	U-Washer • U-podložka	11, 13	55, 64



ETA 06/0106

It. no. NEW č. p. NOVÉ	It. no. OLD č. p. STARÉ	Dimensions/ Rozmery [mm]			pcs. / package ks./bal.	€ / pcs. €/ks	kg / pcs. kg/ks.
		A	B	C			
AA60280 ¹⁾	07680 01 ²⁾	83	62	40	50	0,81	0,083
AB90-B	07091 00 ³⁾	88	88	65	100	0,70	0,200
AB105	07106 01 ³⁾	103	103	90	50	1,46	0,400
AB70	07071 01 ³⁾	70	70	55	100	0,56	0,108
AB90-135GR-B ¹⁾	07092 00 ³⁾	88	88	65	1	1,54	0,208
AB105-135GR-B ¹⁾	07107 00 ³⁾	103	103	90	1	2,53	0,400

1) Currently without ETA / Momentálne bez ETA

2) Ripped/s rebrom

3) Not ripped/bez rebra

Prices quoted are exclusive of VAT / Ceny sú uvedené bez DPH

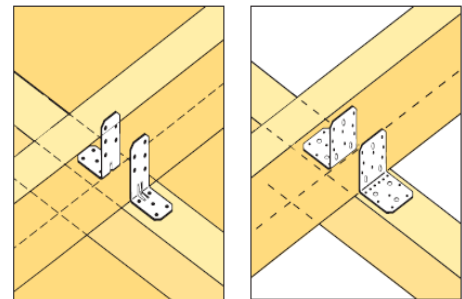
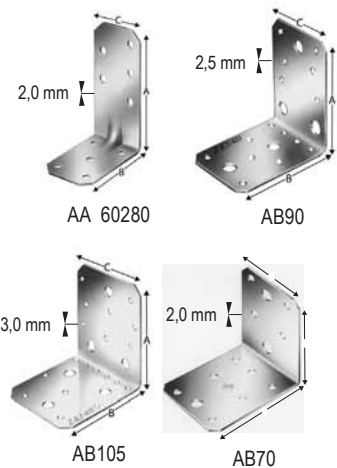

ETA 07/0055 (ABB)

It. no. NEW č. p. NOVÉ	It. no. OLD č. p. STARÉ	Dimensions/ Rozmery [mm]			pcs. / package ks./bal.	€ / pcs. €/ ks	kg / pcs. kg/ks.
		A	B	C			
ABB40390	07390 01	93	93	40	100	1,16	0,161
ABL7514G-B	10010 00	75	75	50	50	4,84	0,300
ABL10014G-B	10030 00	100	75	60	25	7,95	0,560
ABL15014G-B	10040 00	150	75	60	25	10,57	0,750
ABL15017G-B	10041 00	150	75	60	25	10,57	0,750
ABS10011G-B	10020 00	100	50	50	50	6,19	0,410
ABS10014G-B	10021 00	100	50	50	50	6,19	0,410

Prices quoted are exclusive of VAT / Ceny sú uvedené bez DPH

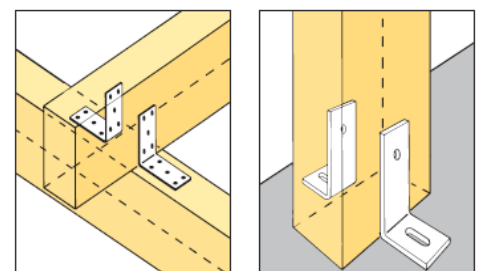
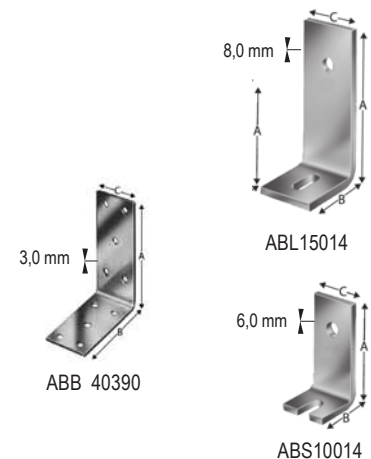



ETA 06/0106 ETA 07/0055

It. no. NEW č. p. NOVÉ	It. no. OLD č. p. STARÉ	Dimensions/ Rozmery [mm]			pcs. / package ks./bal.	€ / pcs. € / ks	kg / pcs. kg/ks.
		A	B	C			
ABR9020	–	88	88	65	50	0,66	0,168
ABR9015	–	89	89	60	100	0,64	0,110
ABR90-B	0709000 ²⁾	90	90	65	50	0,70	0,208
ABR105-B	0710500 ²⁾	105	105	90	50	1,46	0,400
ABR105/13-B ¹⁾	ABR105/13 ²⁾	105	105	90	50	2,10	0,400
ABR70	0707001 ²⁾	70	70	55	50	0,56	0,108
ABR100	–	100	100	90	50	1,32	0,260
ABR170	ABR170	100	100	90	25	1,74	0,170
E20/3	–	170	113	95	25	3,86	0,583

1) Currently without ETA / Momentálne bez ETA

2) Ripped/s rebrom

Prices quoted are exclusive of VAT / Ceny sú uvedené bez DPH

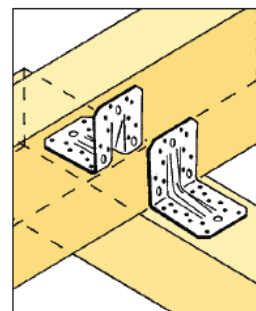
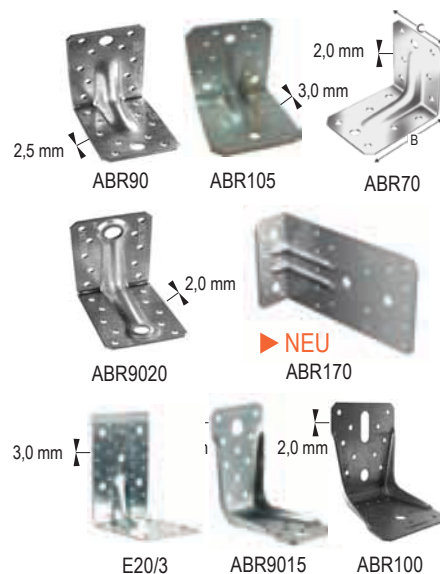

ETA 07/0194

It. no. NEW č. p. NOVÉ	It. no. OLD č. p. STARÉ	Dimensions/ Rozmery [mm]			pcs. / package ks./bal.	€ / pcs. € / ks	kg / pcs. kg/ks.
		A	B	C			
AC35350 ¹⁾	07350 00	50	50	35	100	0,53	0,048
AB55365 ¹⁾	07365 01	65	65	55	100	1,13	0,125
AF90265 ¹⁾	07265 01	67	67	90	100	1,51	0,174
ADR6090	07690 01	90	60	60	100	1,32	0,164
ADR6035-B	07635 00	60	35	60	100	0,89	0,100
ADR6191	07691 01	90	60	60	100	1,35	0,164
ADR6292	07692 01	90	60	60	100	1,38	0,164

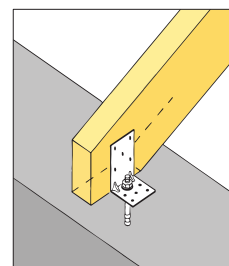
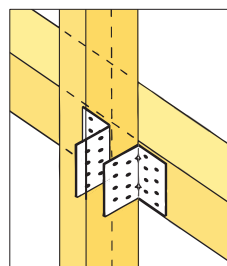
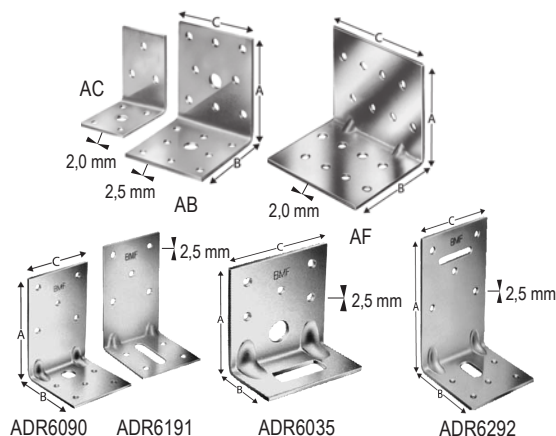

1) Currently without ETA / Momentálne bez ETA

Prices quoted are exclusive of VAT / Ceny sú uvedené bez DPH



ETA 07/0055

It. no. NEW č. p. NOVÉ	It. no. OLD č. p. STARÉ	Dimensions/ Rozměry [mm]			pcs. / package ks./bal.	€ / pcs. €/ ks.	kg / pcs. kg/ks.
		A	B	C			
AE48	07048 01	90	48	48	100	1,31	0,134
AE76	07076 01	90	48	76	100	1,97	0,206
AE116	07116 01	90	48	116	50	2,90	0,340
AG40312	07312 01	119	91	40	100	1,65	0,184
AG40412	07412 01	120	92	40	50	2,08	0,243
AG40314-B	07314 00	141	91	40	50	1,77	0,209
AG40414	07414 01	142	92	40	50	2,26	0,276
AJ60416	07060 01	164	84	60	50	3,48	0,427
AJ80416	07080 01	164	84	80	25	4,70	0,588
AJ99416	07099 01	164	84	100	25	5,59	0,724
AKR95G-B	10050 00	95	85	65	25	3,26	0,324
AKR95LG-B	10055 00	95	85	65	25	3,26	0,319
AKR135G-B	10060 00	135	85	65	25	3,84	0,404
AKR135LG-B	10065 00	135	85	65	25	3,84	0,398
AKR285G-B	10080 00	285	85	65	25	5,84	0,749
AKR285LG-B	10085 00	285	85	65	25	5,84	0,722
ANP254440 ¹⁾	08444 01	40	40	40	200	0,86	0,062
ANP254460 ¹⁾	08446 01	40	40	60	150	0,75	0,089
ANP256640 ¹⁾	08664 01	60	60	40	100	0,72	0,090
ANP256650 ¹⁾	08665 01	60	60	50	150	0,77	0,112
ANP256660 ¹⁾	08666 01	60	60	60	100	0,81	0,136
ANP256680 ¹⁾	08668 01	60	60	80	100	1,43	0,178
ANP2566100 ¹⁾	08661 01	60	60	100	50	1,74	0,220
ANP258860 ¹⁾	08886 01	80	80	60	100	1,03	0,178
ANP258880 ¹⁾	08888 01	80	80	80	50	1,35	0,240
ANP2588100-B ¹⁾	08881 00	80	80	100	50	2,15	0,298
ANP25101060 ¹⁾	08116 01	100	100	60	50	1,82	0,224
ANP25101080-B ¹⁾	08118 00	100	100	80	50	2,22	0,296
ANP251010100 ¹⁾	08111 01	100	100	100	50	2,33	0,372
ANP254660 ¹⁾	08466 01	40	60	60	150	0,95	0,111
ANP256860 ¹⁾	08686 01	60	80	60	100	1,41	0,157
ANP2561060-B ¹⁾	08616 00	60	100	60	100	1,47	0,178
ANP251020100-B ¹⁾	08121 00	100	200	100	25	4,77	0,560

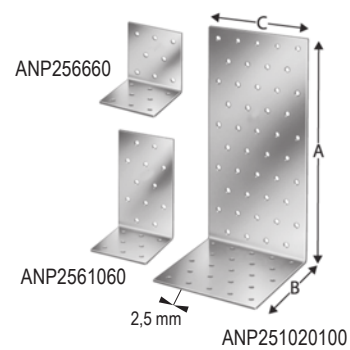
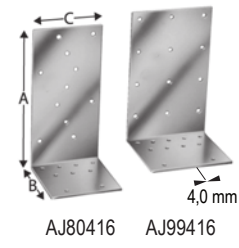
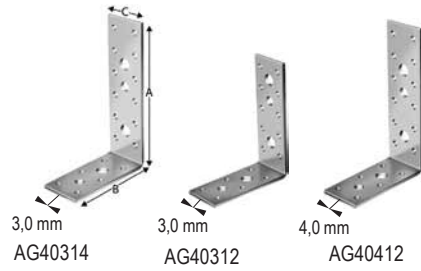
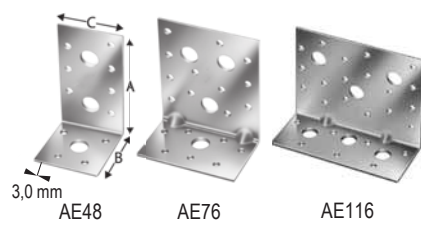

1) Currently without ETA / Momentálne bez ETA
Prices quoted are exclusive of VAT / Ceny sú uvedené bez DPH

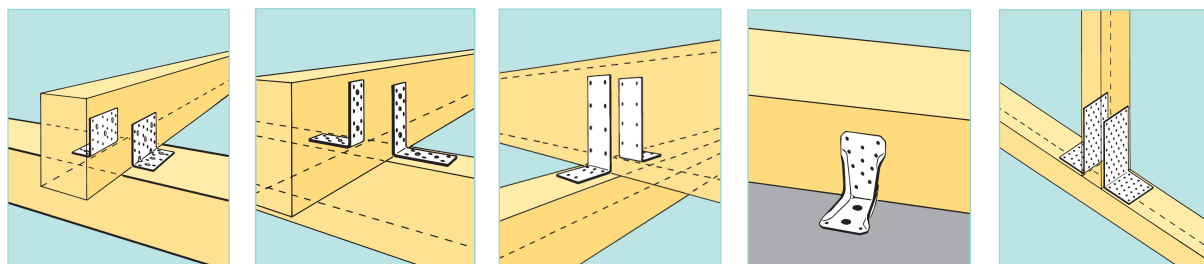



ETA 07/0055

It. no. NEW č. p. NOVÉ	It. no. OLD č. p. STARÉ	Dimensions/ Rozmery [mm]			pcs. / package ks./bal.	€ / pcs. € / ks	kg / pcs. kg/ks.
		A	B	C			
ANPS204425 ¹⁾	30001 01	40	40	25	200	0,36	0,031
ANPS204440 ¹⁾	30444 01	40	40	40	200	0,43	0,054
ANPS204625 ¹⁾	30003 01	40	60	25	200	0,43	0,040
ANPS204460-B ¹⁾	30446 00	40	40	60	200	0,42	0,070
ANPS206625 ¹⁾	30005 01	60	60	25	200	0,43	0,046
ANPS206640 ¹⁾	30664 01	60	60	40	100	0,46	0,071
ANPS206650-B ¹⁾	30665 00	60	60	50	150	0,52	0,090
ANPS206660-B ¹⁾	30666 00	60	60	60	100	0,54	0,107
ANPS206680 ¹⁾	30668 01	60	60	80	100	0,80	0,140
ANPS208860-B ¹⁾	30886 00	80	80	60	100	0,79	0,140
ANPS208880 ¹⁾	30888 01	80	80	80	50	0,97	0,186
BNV33	07615 00	61	33	180	50	3,73	0,203
AB6983	AB6983	69	83	300	20	8,73	1,290
AB36125	AB36125	36	125	247	25	8,11	0,636

1) Currently without ETA-CE / Momentálne bez ETA-CE

Prices quoted are exclusive of VAT / Ceny sú uvedené bez DPH

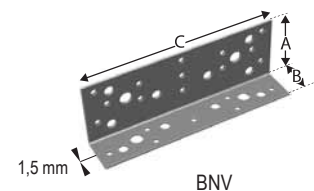
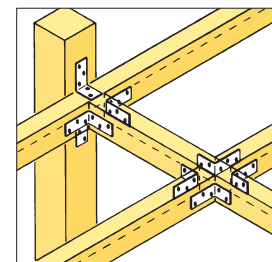

ETA 07/0055

It. no. NEW č. p. NOVÉ	It. no. OLD č. p. STARÉ	Dimensions/ Rozmery [mm]			pcs. / package ks./bal.	€ / pcs. € / ks	kg / pcs. kg/ks.
		A	B	C			
KNAG90-B	19090 00	90	90	65	50	2,77	0,296
KNAG130-B	19130 00	125	125	80	50	4,95	0,440
KNAG170-B	19170 00	160	160	95	25	7,43	0,730
KNAG210-B	19210 00	200	200	100	15	9,90	1,070

Prices quoted are exclusive of VAT / Ceny sú uvedené bez DPH

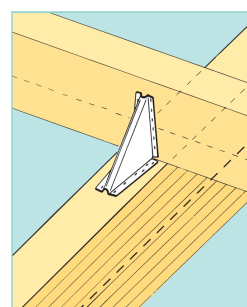
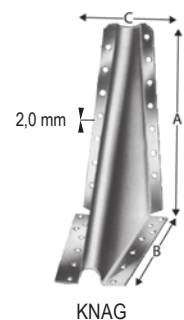



ETA 06/0270

It. no. NEW č. p. NOVÉ	It. no. OLD č. p. STARÉ	Dimensions/ Rozměry [mm]				pcs. / package ks./bal.	€/ pcs. €/ ks.	kg / pcs. kg/ks.
		A	B	C	D			
BSN36/142	03202 01	36	142	40	80	50	2,78	0,380
BSN40/99-B	03003 00	40	99	37	72	50	2,45	0,250
BSN40/110	03103 01	40	110	37	72	50	2,28	0,270
BSN40/140-B	03203 00	40	140	40	80	50	2,78	0,380
BSN45/96	03006 01	45	96	37	72	50	2,45	0,250
BSN45/105	03106 01	45	105	37	72	50	2,28	0,270
BSN45/137	03204 01	45	137	40	80	50	2,78	0,380
BSN45/167	03301 01	45	167	40	80	40	3,45	0,433
BSN45/197	03402 01	45	197	42	87	25	4,61	0,580
BSN48/95	03007 01	48	95	37	72	50	2,45	0,250
BSN48/136	03205 01	48	136	40	80	50	2,78	0,380
BSN48/166	03302 01	48	166	40	80	40	3,45	0,433
BSN48/226-B	03501 00	48	226	39	85	25	5,07	0,650
BSN51/93	03009 01	51	93	37	72	50	2,45	0,250
BSN51/105	03109 01	51	105	37	72	50	1,68	0,270
BSN51/135	03206 01	51	135	40	80	50	2,01	0,380
BSN51/164	03303 01	51	164	40	80	40	2,50	0,433
BSN51/195	03403 01	51	195	42	87	25	4,51	0,580
BSN60/100-B	03112 00	60	100	37	72	50	1,42	0,270
BSN60/130-B	03209 00	60	130	40	80	50	2,78	0,380
BSN60/160-B	03306 00	60	160	40	80	40	2,35	0,433
BSN60/190-B	03406 00	60	190	42	87	25	4,51	0,580
BSN60/220-B	03503 00	60	220	40	80	25	5,07	0,650
BSN64/98	03115 01	64	98	37	72	50	2,33	0,270
BSN64/128-B	03212 00	64	128	40	80	50	2,78	0,380
BSN70/125	03215 01	70	125	40	80	50	2,86	0,380
BSN70/155-B	03307 00	70	155	40	80	40	3,45	0,433
BSN73/124	03216 01	73	124	40	80	50	2,78	0,380
BSN73/153	03308 01	73	153	40	80	40	3,53	0,433
BSN73/183-B	03408 00	73	183	42	87	25	4,51	0,580
BSN76/120	03218 01	76	120	40	80	50	2,78	0,380
BSN76/152	03309 01	76	152	40	80	40	3,45	0,433
BSN80/120-B	03221 00	80	120	40	80	50	1,52	0,380
BSN80/150	03312 01	80	150	40	80	40	2,42	0,433
BSN80/180-B	03412 00	80	180	42	87	25	3,14	0,580
BSN80/210-B	03506 00	80	210	39	85	25	5,07	0,650
BSN90/145	03315 01	90	145	40	80	40	2,40	0,433
BSN98/141	03317 01	98	141	40	80	40	3,45	0,433
BSN100/90	03224 01	100	90	40	80	50	2,78	0,343
BSN100/140-B	03318 00	100	140	40	80	40	1,85	0,433
BSN100/170-B	03415 00	100	170	42	87	25	4,51	0,580
BSN100/200-B	03509 00	100	200	39	85	25	5,07	0,650
BSN115/162-B	03418 00	115	162	42	87	25	4,51	0,580
BSN115/190-B	03512 00	115	190	42	87	25	5,07	0,650
BSN120/119-B	03612 00	120	119	40	80	25	3,45	0,467
BSN120/160-B	03421 00	120	160	42	87	25	2,56	0,580
BSN120/190-B	03515 00	120	190	39	85	25	5,07	0,650
BSN127/126-B	03321 00	127	126	40	80	40	7,47	0,421
BSN127/186-B	03518 00	127	186	42	87	25	5,07	0,650
BSN140/139-B	03714 00	140	139	40	80	25	4,51	0,535
BSN140/180-B	03521 00	140	180	39	85	25	2,84	0,650
BSN150/145-B	03424 00	150	145	42	87	25	7,36	0,545

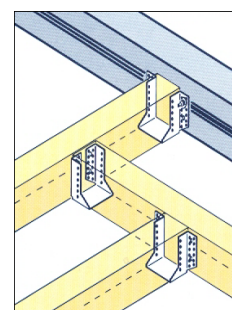
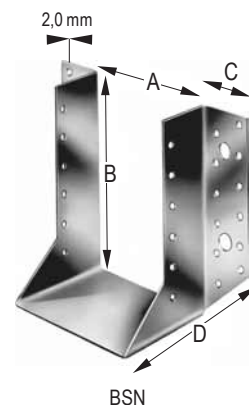

Prices quoted are exclusive of VAT / Ceny sú uvedené bez DPH



ETA 06/0270

It. no. NEW č. p. NOVÉ	It. no. OLD č. p. STARÉ	Dimensions/ Rozměry [mm]				pcs. / package ks./bal.	€ / pcs. € / ks	kg / pcs. kg/ks.
		A	B	C	D			
BSI40/110-B	04103 00	40	110	37	72	50	2,81	0,250
BSI45/96	04006 01	45	96	37	72	50	2,73	0,200
BSI48/95	04003 01	48	95	37	72	50	2,73	0,200
BSI48/136	04205 01	48	136	40	80	50	3,31	0,320
BSI48/166	04302 01	48	166	40	80	40	4,06	0,370
BSI60/100-B	04112 00	60	100	37	72	50	2,23	0,257
BSI60/160-B	04306 00	60	160	40	80	40	3,86	0,390
BSI64/98-B	04115 00	64	98	37	72	50	2,51	0,257
BSI64/128-B	04212 00	64	128	40	80	50	2,78	0,340
BSI70/125-B	04215 00	70	125	40	80	50	3,12	0,340
BSI73/124	04216 01	73	124	40	80	50	3,12	0,340
BSI73/153-B	04308 00	73	153	40	80	40	3,71	0,390
BSI76/120-B	04218 00	76	120	40	80	50	2,78	0,380
BSI80/120-B	04221 00	80	120	40	80	50	2,38	0,380
BSI80/150-B	04312 00	80	150	40	80	40	3,45	0,430
BSI80/180-B	04412 00	80	180	42	87	25	4,51	0,580
BSI80/210-B	04506 00	80	210	39	85	25	5,07	0,650
BSI90/145-B	04315 00	90	145	40	80	40	3,45	0,430
BSI98/141	04317 01	98	141	40	80	40	3,45	0,430
BSI100/90-B	04224 00	100	90	40	80	50	2,78	0,343
BSI100/140-B	04318 00	100	140	40	80	40	2,88	0,430
BSI100/170-B	04415 00	100	170	42	87	25	4,51	0,580
BSI100/200-B	04509 00	100	200	39	85	25	5,07	0,650
BSI115/162-B	04418 00	115	162	42	87	25	4,51	0,580
BSI115/190-B	04512 00	115	190	42	87	25	5,07	0,650
BSI120/119-B	04612 00	120	119	40	80	25	3,45	0,467
BSI120/160-B	04421 00	120	160	42	87	25	3,87	0,580
BSI120/190-B	04515 00	120	190	39	85	25	5,07	0,650
BSI140/139-B	04714 00	140	139	40	80	25	4,51	0,535
BSI140/180-B	04521 00	140	180	39	85	25	4,30	0,650

Prices quoted are exclusive of VAT / Ceny sú uvedené bez DPH

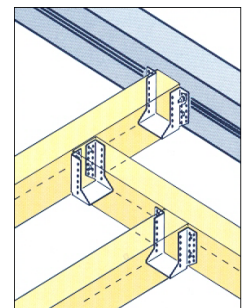
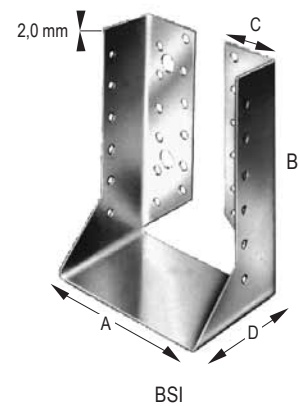



ETA 06/0270

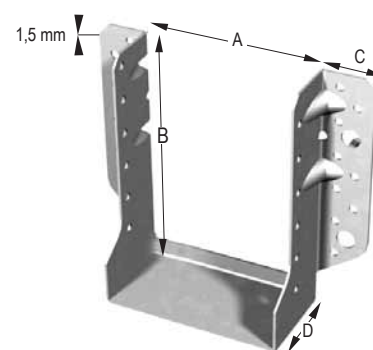

SBE

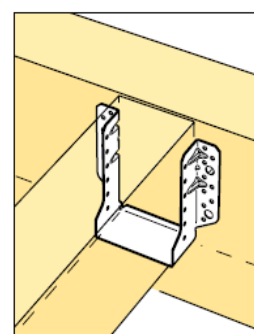

It. no. NEW č. p. NOVÉ	It. no. OLD č. p. STARÉ	Dimensions/ Rozměry [mm]				pcs. / package ks./bal.	€ / pcs. € / ks	kg / pcs. kg/ks.
		A	B	C	D			
SBE40/95	09010 01	40	95	30	55	70	2,05	0,170
SBE40/110	09110 01	40	110	30	55	70	2,05	0,195
SBE40/140	09210 01	40	140	30	55	50	2,45	0,240
SBE45/93	09013 01	45	93	30	55	70	2,05	0,170
SBE45/108	09113 01	45	108	30	55	70	2,05	0,195
SBE45/138	09213 01	45	138	30	55	50	2,45	0,240
SBE45/168	09313 01	45	168	30	55	30	3,04	0,290
SBE48/91	09016 01	48	91	30	55	70	2,05	0,170
SBE48/136	09216 01	48	136	30	55	50	2,45	0,240
SBE48/166	09316 01	48	166	30	55	30	3,04	0,290
SBE51/90	09019 01	51	90	30	55	70	2,05	0,170
SBE51/135	09219 01	51	135	30	55	50	2,45	0,240
SBE60/100	09122 01	60	100	30	55	70	1,69	0,195
SBE60/130	09222 01	60	130	30	55	50	2,45	0,240
SBE60/160	09322 01	60	160	30	55	30	2,97	0,290
SBE64/98	09125 01	64	98	30	55	70	2,05	0,195
SBE64/128	09225 01	64	128	30	55	50	2,45	0,240
SBE70/125	09228 01	70	125	30	55	50	2,41	0,240
SBE70/155	09328 01	70	155	30	55	30	3,04	0,290
SBE73/154	09331 01	73	154	30	55	30	3,04	0,290
SBE76/122	09234 01	76	122	30	55	50	2,45	0,240
SBE76/152	09334 01	76	152	30	55	30	3,04	0,290
SBE80/120	09237 01	80	120	30	55	50	1,95	0,240
SBE80/150	09337 01	80	150	30	55	30	2,97	0,290
SBE90/145	09340 01	90	145	30	55	30	3,04	0,290
SBE98/141	09343 01	98	141	30	55	30	3,04	0,290
SBE100/140	09346 01	100	140	30	55	30	2,34	0,290

Prices quoted are exclusive of VAT / Ceny sú uvedené bez DPH



ETA 06/0270

It. no. NEW č. p. NOVÉ	Dimensions/ Rozmery [mm]				pcs. / package ks./bal.	€ / pcs. € / ks	kg / pcs. kg/ks.
	A	B	C	D			
SBG40/110	40	110	27,5	55	70	1,88	0,170
SBG45/108	45	108	27,5	55	70	1,88	0,170
SBG45/137	45	137	27,5	55	50	2,27	0,210
SBG51/105	51	105	27,5	55	70	1,88	0,170
SBG51/135	51	135	27,5	55	50	2,27	0,210
SBG51/164	51	164	27,5	55	30	2,78	0,260
SBG60/100	60	100	27,5	55	70	1,44	0,170
SBG60/130	60	130	27,5	55	50	2,27	0,210
SBG60/160	60	160	27,5	55	30	2,75	0,260
SBG60/190	60	190	27,5	55	25	2,88	0,290
SBG60/220	60	220	27,5	55	25	3,38	0,320
SBG70/125	70	125	27,5	55	50	2,20	0,210
SBG70/155	70	155	27,5	55	30	2,78	0,260
SBG80/120	80	120	27,5	55	50	1,63	0,210
SBG80/150	80	150	27,5	55	30	2,75	0,260
SBG80/180	80	180	27,5	55	25	2,88	0,290
SBG80/210	80	210	27,5	55	25	3,38	0,320
SBG90/145	90	145	27,5	55	30	2,78	0,260
SBG100/140	100	140	27,5	55	30	1,98	0,260
SBG100/170	100	170	27,5	55	25	2,88	0,290
SBG100/200	100	200	27,5	55	25	3,38	0,320
SBG120/160	120	160	27,5	55	25	1,87	0,290
SBG120/190	120	190	27,5	55	25	3,38	0,320
SBG140/180	140	180	27,5	55	25	2,19	0,320

Prices quoted are exclusive of VAT / Ceny sú uvedené bez DPH

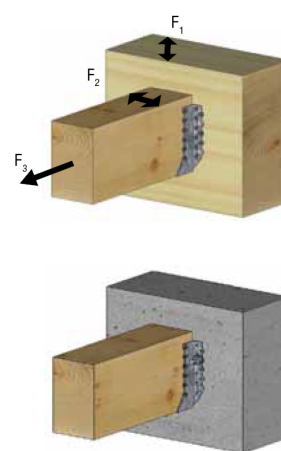
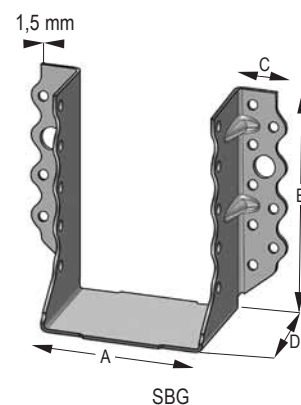



ETA 06/0270

It. no. NEW č. p. NOVÉ	Dimensions/ Rozměry [mm]				pcs. / package ks./bal.	€/ pcs. €/ ks	kg / pcs. kg/ks.
	A	B	C	D			
BSD80/100	80	100	32	52	50	8,45	0,358
BSD100/120	100	120	32	52	25	9,24	0,360
BSD100/240	100	240	32	52	20	13,56	0,742
BSD120/180	120	180	32	52	25	10,10	0,540
BSD120/240	120	240	32	52	20	11,78	0,768
BSD120/300	120	300	32	52	20	10,12	0,830
BSD120/320	120	320	32	52	20	10,29	0,880
BSD140/200	140	200	32	52	25	10,45	0,600
BSD140/240	140	240	32	52	20	12,25	0,832
BSD140/260	140	260	32	52	25	10,79	0,750
BSD140/300	140	300	32	52	20	11,17	0,850
BSD140/320	140	320	32	52	20	11,69	0,900
BSD160/160	160	160	32	52	25	9,96	0,614
BSD160/200	160	200	32	52	20	10,78	0,717
BSD160/240	160	240	32	52	10	13,56	0,814
BSD160/260	160	260	32	52	25	11,46	0,760
BSD160/280	160	280	32	52	10	11,55	0,922
BSD160/300	160	300	32	52	10	11,66	0,973
BSD160/320	160	320	32	52	10	18,59	1,024
BSD180/180	180	180	32	52	20	13,09	0,691
BSD180/220	180	220	32	52	20	12,25	0,794
BSD180/280	180	280	32	52	10	18,11	0,947
BSD180/320	180	320	32	52	20	15,47	0,930
BSD200/200	200	200	32	52	20	11,74	0,768
BSD200/240	200	240	32	52	20	15,13	0,870
BSD200/280	200	280	32	52	20	15,62	0,850
BSDI80/100	80	100	32	52	50	9,83	0,358
BSDI120/240	120	240	32	52	20	13,00	0,768
BSDI140/200	140	200	32	52	25	12,25	0,600
BSDI140/240	140	240	32	52	20	13,51	0,794
BSDI140/260	140	260	32	52	25	11,87	0,750
BSDI140/300	140	300	32	52	20	12,98	0,850
BSDI160/160	160	160	32	52	25	11,02	0,614
BSDI160/200	160	200	32	52	20	11,87	0,717
BSDI160/260	160	260	32	52	25	12,42	0,760
BSDI160/280	160	280	32	52	20	12,82	0,810
BSDI160/300	160	300	32	52	20	13,21	0,860
BSDI180/220	180	220	32	52	20	13,51	0,794
BSDI200/200	200	200	32	52	20	13,00	0,768
BSDI200/240	200	240	32	52	20	16,73	0,870

Prices quoted are exclusive of VAT / Ceny sú uvedené bez DPH

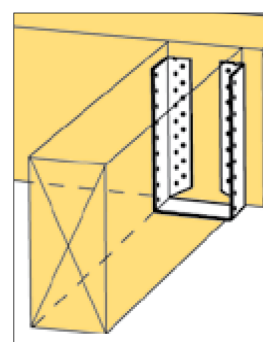
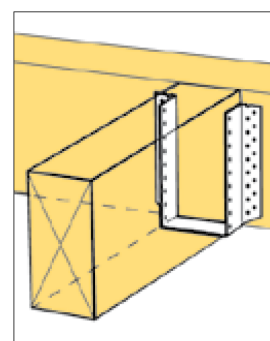
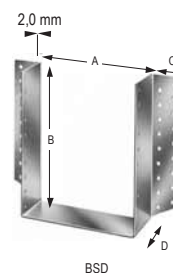



ETA 06/0270

It. no. NEW č. p. NOVÉ	It. no. OLD č. p. STARÉ	Dimensions/ Rozměry [mm]				pcs. / package ks./bal.	€ / set – 2 pcs. € / set - 2 ks	kg / pcs. kg/ks.
		A	B	C	D			
BSN2P30/98-B	03010 00	30	98	37,5	73	20	3,73	0,416
BSN2P30/152-B	03011 00	30	152	40,0	80	20	4,87	0,425
BSN2P30/182-B	03012 00	30	182	42,0	87	20	5,95	0,678

Prices quoted are exclusive of VAT / Ceny sú uvedené bez DPH

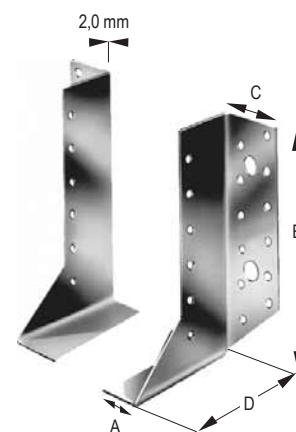

BSN2P

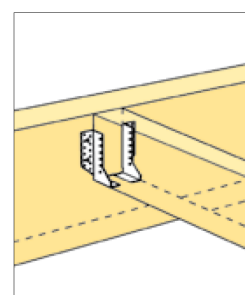

ETA 07/0150

It. no. NEW č. p. NOVÉ	It. no. OLD č. p. STARÉ	Dimensions/ Rozměry [mm]				pcs. / package ks./bal.	€ / pcs. € / ks	kg / pcs. kg/ks.
		A	B	C	D			
BSIL90/195	06200 01	90	195	42	87	25	5,92	0,640
BSIL90/235	06202 01	90	235	39	85	25	6,86	0,769
BSIL100/190	06206 01	100	190	42	87	25	6,03	0,640
BSIL100/230	06210 01	100	230	39	85	25	7,79	0,768
BSIL115/223	06204 01	115	223	39	85	25	7,68	0,756
BSIL120/180	06208 01	120	180	42	87	25	6,03	0,640
BSIL120/220	06212 01	120	220	39	85	25	7,79	0,768

Prices quoted are exclusive of VAT / Ceny sú uvedené bez DPH



BSIL

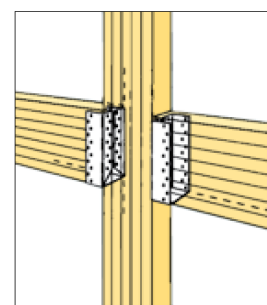



ETA 07/0150

It. no. NEW č. p. NOVÉ	It. no. OLD č. p. STARÉ	Dimensions/ Rozměry [mm]				pcs. / package ks./bal.	€ / pcs. € / ks	kg / pcs. kg/ks.
		A	B	C	D			
BSS60/90-B	05050 00	60	90	58	48	25	4,84	0,300
BSS60/110-B	05070 00	60	110	58	48	25	5,38	0,360
BSS80/110-B	05100 00	80	110	58	48	25	5,84	0,370
BSS80/130-B	05180 00	80	130	58	48	25	6,42	0,440
BSS80/150-B	05280 00	80	150	58	48	25	6,97	0,520
BSS100/130-B	05240 00	100	130	58	48	25	6,77	0,448
BSS100/150-B	05330 00	100	150	58	48	25	7,33	0,504
BSS100/170-B	05380 00	100	170	58	48	25	7,93	0,585
BSS100/190-B	05385 00	100	190	58	48	25	8,47	0,650
BSS120/170-B	05430 00	120	170	58	48	25	8,21	0,588
BSS120/190-B	05530 00	120	190	58	48	25	8,76	0,640
BSS120/210-B	05570 00	120	210	58	48	25	9,52	0,712
BSS120/230-B	05630 00	120	230	58	48	25	10,07	0,784
BSS140/150-B	05390 00	140	150	58	48	25	8,07	0,585
BSS160/190-B	05590 00	160	190	58	48	25	9,61	0,680

Prices quoted are exclusive of VAT / Ceny sú uvedené bez DPH

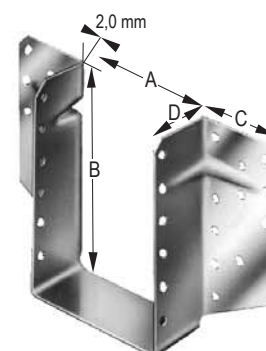

BSS

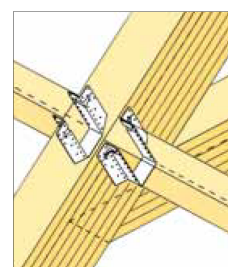

ETA 07/0150

It. no. NEW č. p. NOVÉ	It. no. OLD č. p. STARÉ	Dimensions/ Rozměry [mm]				pcs. / package ks./bal.	€ / pcs. € / ks	kg / pcs. kg/ks.
		A	B	C	D			
GSE120/390/2,5	GSE900/120/2,5	120	390	42	110	11	16,01	1,980
GSE140/380/2,5	GSE900/140/2,5	140	380	42	110	11	16,01	1,980
GSE140/410/2,5	GSE960/140/2,5	140	410	42	110	10	19,71	2,110
GSE140/440/2,5	GSE1020/140/2,5	140	440	42	110	9	18,73	2,240
GSE160/370/2,5	GSE900/160/2,5	160	370	42	110	11	16,01	1,980
GSE160/400/2,5	GSE960/160/2,5	160	400	42	110	10	19,71	2,110
GSE160/430/2,5	GSE1020/160/2,5	160	430	42	110	9	18,73	2,240

Prices quoted are exclusive of VAT / Ceny sú uvedené bez DPH

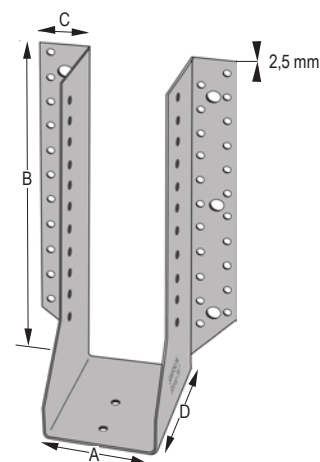

GSE



ETA 07/0125

It. no. NEW č. p. NOVÉ	It. no. OLD č. p. STARÉ	Dimensions/ Rozměry [mm]			pcs. / package ks./bal.	€/ pcs. €/ ks	kg / pcs. kg/ks.
		A	B	C			
BTN90-B	34090 00	90	103	46	25	6,63	0,520
BTN120-B	34120 00	120	103	46	25	8,56	0,672
BTN160-B	34160 00	160	103	46	20	10,57	0,904
BTN200-B	34200 00	200	103	46	15	12,54	1,120
BTN240-B	34240 00	240	103	46	15	15,37	1,347
BT4-90-B	34409 00	90	103	62	25	7,63	0,543
BT4-120-B	34412 00	120	103	62	25	9,35	0,716
BT4-160-B	34416 00	160	103	62	20	11,84	0,953
BT4-200-B	34420 00	200	103	62	15	13,89	1,180
BT4-240-B	34424 00	240	103	62	15	16,52	1,423
BTALU90-B	34509 00	86	103	62	25	11,19	0,225
BTALU120-B	34512 00	116	103	62	25	13,43	0,303
BTALU160-B	34516 00	156	103	62	25	16,26	0,406
BTALU200-B	34520 00	196	103	62	15	19,89	0,509
BTALU240-B	34524 00	236	103	62	15	24,65	0,609
BTALU3000-B	34503 00	3000	103	62	1	310,16	7,980

Prices quoted are exclusive of VAT / Ceny sú uvedené bez DPH

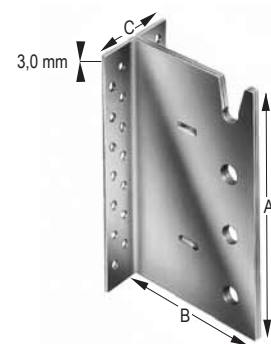

BTN

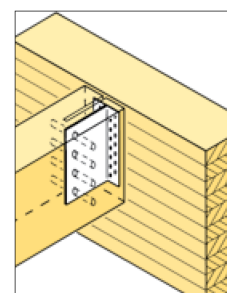

BTALU



ETA 07/0125

It. no. NEW č. p. NOVÉ	It. no. OLD č. p. STARÉ	Dimensions/ Rozměry [mm]			pcs. / package ks./bal.	€/ pcs. €/ ks	kg / pcs. kg/ks.
		A	B	C			
TU12-B	34312 00	96	98	40	50	6,56	0,262
TU16-B	34316 00	134	105	60	50	8,10	0,388
TU20-B	34320 00	174	105	60	25	10,20	0,528
TU24-B	34324 00	214	105	60	25	12,84	0,664
TU28-B	34328 00	254	105	60	20	14,92	0,800
TUS12-B	34312 30	96	98	40	1	10,46	0,262
TUS16-B	34316 30	134	105	60	1	12,84	0,390
TUS20-B	34320 30	174	105	60	1	15,43	0,530
TUS24-B	34324 30	214	105	60	1	18,57	0,660
TUS28-B	34328 30	254	105	60	1	21,44	0,800

Prices quoted are exclusive of VAT / Ceny sú uvedené bez DPH

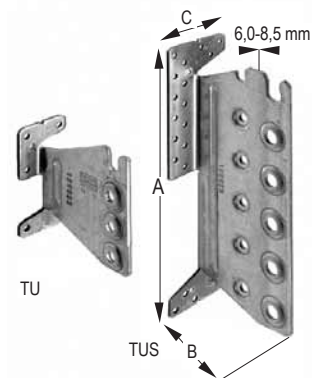

TU

TUS

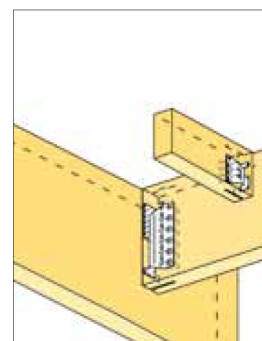



ETA 07/0245

It. no. NEW č. p. NOVÉ	It. no. OLD č. p. STARÉ	Dimensions/ Rozmery [mm]				pcs. / package ks./bal.	€/ pcs. €/ ks	kg / pcs. kg/ks.
		A	B	C	D			
ETB90-B	34709 00	90	60	58	69	25	23,72	0,103
ETB120-B	34712 00	121	60	85	95	25	29,98	0,137
ETB160-B	34716 00	166	60	95	130	25	33,59	0,192
ETB190-B	34719 00	195	75	138	165	25	35,24	0,274
ETB230-B	34723 00	230	75	138	200	25	40,52	0,342

Prices quoted are exclusive of VAT / Ceny sú uvedené bez DPH

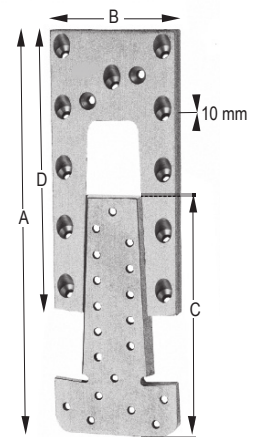

ETB

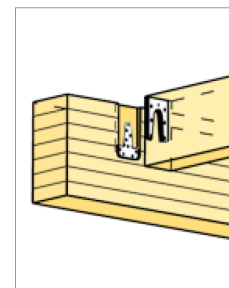

ETA 07/0245

It. no. NEW č. p. NOVÉ	It. no. OLD č. p. STARÉ	Dimensions/ Rozmery [mm]			pcs. / package ks./bal.	€/ pcs. €/ ks	kg / pcs. kg/ks.
		A	B	C			
EL30-B	34803 00	30	55	120	25	19,38	0,117
EL40-B	34804 00	40	55	120	25	23,44	0,162
EL60-B	34806 00	60	55	120	25	27,54	0,242
EL80-B	34808 00	80	55	120	25	30,10	0,324
EL100-B	34810 00	100	55	120	25	33,57	0,405
ELS30-B	34823 00	30	178	178	25	18,44	0,136
ELS40-B	34824 00	40	178	178	25	22,31	0,170
ELS60-B	34826 00	60	178	178	25	26,48	0,263
ELS80-B	34828 00	80	178	178	25	28,89	0,349
ELS100-B	34830 00	100	178	178	25	32,24	0,434

Prices quoted are exclusive of VAT / Ceny sú uvedené bez DPH

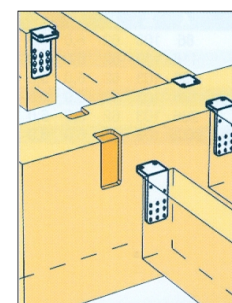
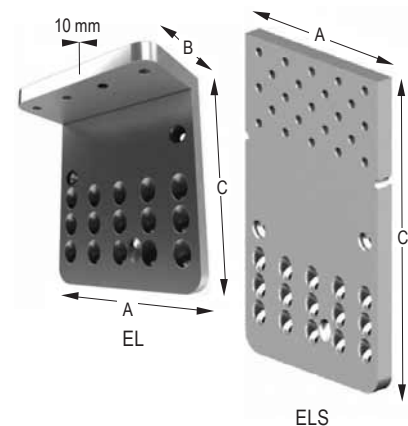



ETA 07/0290

It. no. NEW č. p. NOVÉ	It. no. OLD č. p. STARÉ	Dimensions/ Rozmery [mm]		pcs. / package ks./bal.	€ / pcs. € / ks	kg / pcs. kg/ks.
		A	B			
ATF55/110-B	34751 00	55	110	20	26,20	0,420
ATF55/150-B	34755 00	55	150	20	28,78	0,570
ATF55/190-B	34759 00	55	190	20	32,05	0,710
ATF75/150-B	34775 00	75	150	10	33,55	0,790
ATF75/190-B	34779 00	75	190	10	38,40	0,990

Prices quoted are exclusive of VAT / Ceny sú uvedené bez DPH

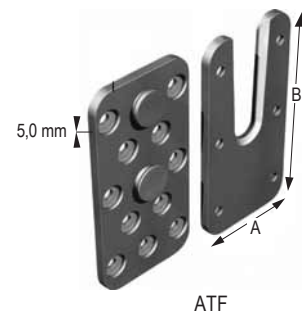

ATF

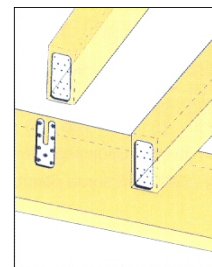

Beam coupling/Trámové spojky

JANEBO®

It. no. NEW č. p. NOVÉ	It. no. OLD č. p. STARÉ	pcs. / package ks./bal.	€ / pcs. € / ks	kg / pcs. kg/ks.
JHH140	80614 00	1	36,64	2,100
JHH200	80620 00	1	42,61	2,500
JHH260	80626 00	1	53,33	3,200
JHH320	80632 00	1	63,66	3,700
JHH380	80638 00	1	75,74	4,500
JHD1-20	80601 00	1	69,37	0,800
JHD1-24	80602 00	1	76,07	1,000
JHD1-36	80603 00	1	93,18	1,600
JHD1-48	80604 00	1	89,82	2,300
JHD1-60	80605 00	1	106,28	3,000

Prices quoted are exclusive of VAT / Ceny sú uvedené bez DPH



JHH200

JHD 1-20

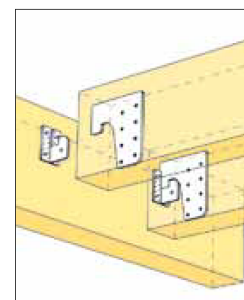

It. no. NEW č. p. NOVÉ	It. no. OLD č. p. STARÉ	Dimensions/ Rozmery [mm]				pcs. / package ks./bal.	€ / pcs. € / ks	kg / pcs. kg/ks.
		A	B	C	D			
BO176/60	80740 00	176	60	60	45	1	38,97	1,000
BO176/80	80741 00	176	60	80	45	1	41,59	1,300
BO176/100	80742 00	176	60	100	45	1	45,52	1,700
BO196/60	80743 00	196	60	60	45	1	41,59	1,100
BO196/80	80744 00	196	60	80	45	1	45,52	1,400
BO196/100	80745 00	196	60	100	45	1	48,39	1,800
BO216/60	80746 00	216	60	60	45	1	42,89	1,200
BO216/80	80747 00	216	60	80	45	1	46,82	1,500
BO216/100	80748 00	216	60	100	45	1	49,71	1,900
BO236/60	80749 00	236	60	60	45	1	44,21	1,300
BO236/80	80750 00	236	60	80	45	1	48,39	1,600
BO236/100	80751 00	236	60	100	45	1	51,00	2,000

Prices quoted are exclusive of VAT / Ceny sú uvedené bez DPH

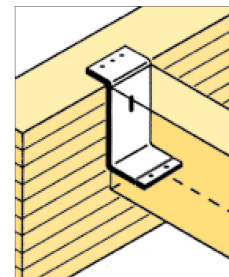
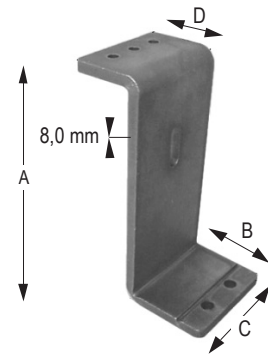

It. no. NEW č. p. NOVÉ	It. no. OLD č. p. STARÉ	Dimensions/ Rozmery [mm]			pcs. / package ks./bal.	€ / pcs. € / ks	kg / pcs. kg/ks.
		A	B	C			
TALU3000-B	34603 00	20	203	3000	1	422,58	10,560

Prices quoted are exclusive of VAT / Ceny sú uvedené bez DPH

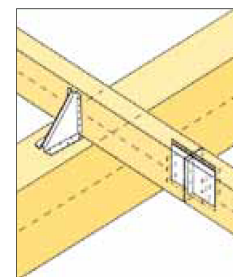
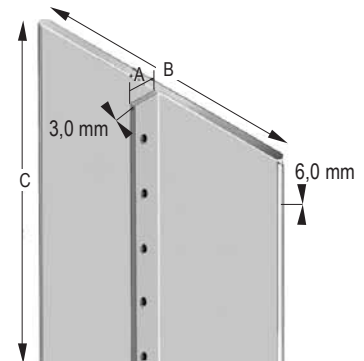

It. no. NEW č. p. NOVÉ	It. no. OLD č. p. STARÉ	pcs. / package ks./bal.	€ / pcs. € / ks	kg / pcs. kg/ks.
MOET	34903 00	1	462,00	3,900
ETTP90-160	ETTP90-160	1	121,97	1,038
ETTP190-230	ETTP190-230	1	200,38	1,460
MOEL	34904 00	1	519,82	3,350
MOATF55	34905 00	1	121,97	1,550
MOATF75	34906 00	1	121,97	1,450
FRATF55	34907 00	1	121,97	1,450
FRATF75	34908 00	1	121,97	1,400
BTBS12	34901 00	1	574,99	6,600
BTBS8	34902 00	1	304,92	1,600

Prices quoted are exclusive of VAT / Ceny sú uvedené bez DPH

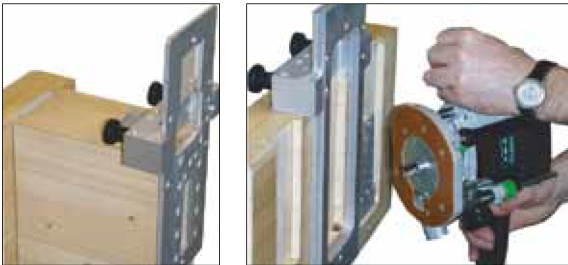

ETB

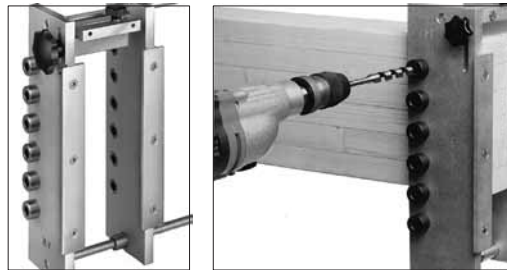

Joist and support bracket / skrytá papuča trámu



EL

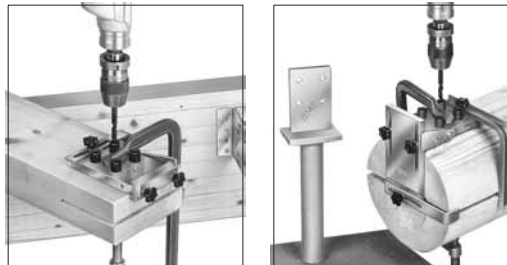

for/pre: joist and support bracket 90 / skrytá papuča trámu 90

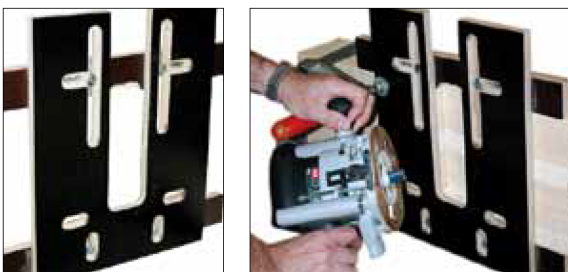

ATF



ETA-04/0042 + 06/0034

It. no. NEW č. p. NOVÉ	Intended for / Určené pre	Dimensions/ Rozmery [mm]			pcs. / package ks./bal.	€/ pcs. €/ ks	kg / pcs. kg/ks.
		A	B	C			
With mounting arm/S montážnym ramenom							
ITSE239/61	MTT359.5	ITT359.5	61	239	54	25	0,310
ITSE299/61	MIT3511.88		61	299	54	25	0,340
ITSE299/92	MTT411.88	ITT411.88	92	299	54	20	0,390
ITSE359/61	MIT3514	ITT3514	61	359	54	20	0,440
ITSE359/92	MIT414	ITT414	92	359	54	15	0,467
Without mounting arm/Bez montážneho ramena							
IUSE239/61	IUT3510	U3510/14	61	239	51	30	0,262
IUSE299/61	IUT3512	U3510/14	61	299	51	25	0,338
IUSE299/92	IUT412	HU410	92	299	51	30	0,329
IUSE359/61	IUT3514	U3510/14	61	359	51	30	0,393
IUSE359/92	IUT414	HU416	92	359	51	30	0,386
IUSE399/61	IUT3514		61	399	51	25	0,420
IUSE399/92	IUT380/91	HU416	92	399	51	30	0,424
Inclined And oblique/Naklonené a šikmé							
LSSUI25			45	-	216	25	6,12 0,360
LSSUI35			60	146	216	25	8,45 0,400
LSSU410			90	230	216	25	11,09 0,660
Drawstring/Sťahovacia šnúra							
LSTA21			32	-	533	50	6,52 0,120

 Price and delivery time on request /Cena a doba dodania na vyžiadanie

Prices quoted are exclusive of VAT / Ceny sú uvedené bez DPH

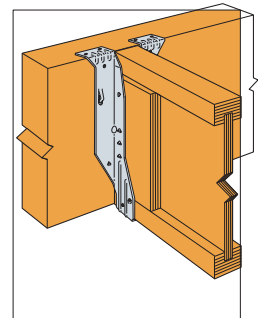
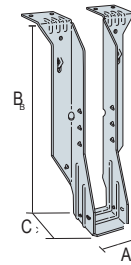

ITSE

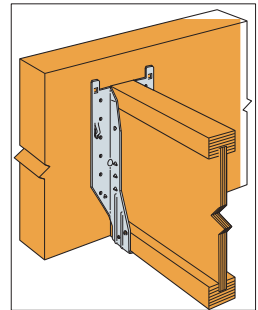
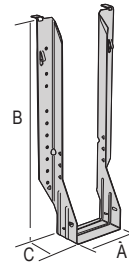

IUSE

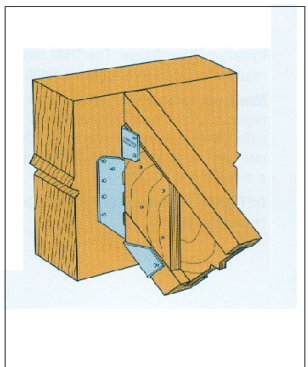
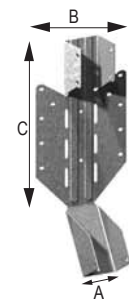

LSSU





ETA 07/0137

It. no. NEW č. p. NOVÉ	It. no. OLD č. p. STARÉ	Dimensions/ Rozmery [mm]				pcs. / package ks./bal.	€ / pcs. € / ks	kg / pcs. kg/ks.
		A	B	C	D			
UNI96L-B	01300 00	96	34	35	46	100	1,08	0,080
UNI96R-B	01301 00	96	34	35	46	100	1,08	0,080
UNI100L-B	01200 00	100	52,5	62,5	47,5	100	1,49	0,151
UNI100R-B	01201 00	100	52,5	62,5	47,5	100	1,49	0,151
UNI130L-B	01100 00	130	61,5	62,5	58	50	2,45	0,244
UNI130R-B	01101 00	130	61,5	62,5	58	50	2,45	0,244
UNI190L-B	01000 00	192	49,5	49,5	96	50	2,05	0,204
UNI190R-B	01002 00	192	49,5	49,5	96	50	2,05	0,204

Prices quoted are exclusive of VAT / Ceny sú uvedené bez DPH

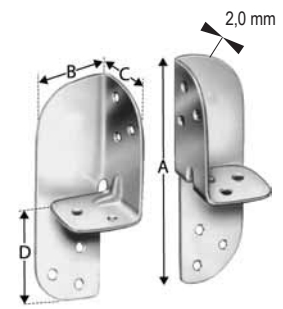

UNI96L

UNI96R

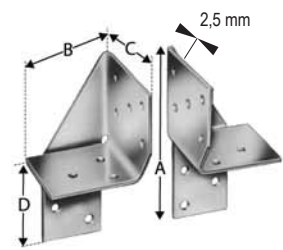

UNI100L

UNI100R

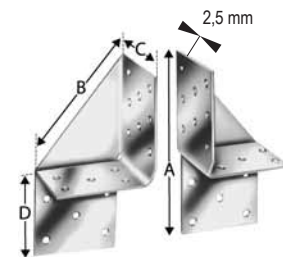

UNI130L

UNI130R

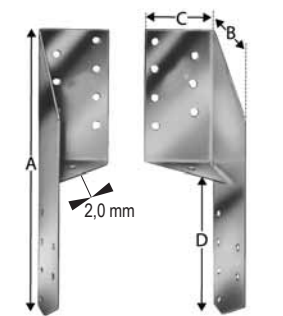

UNI190L

UNI190R

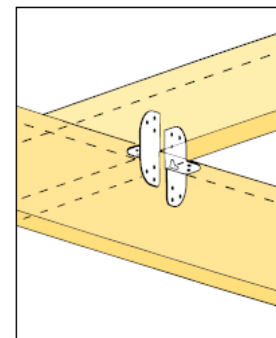



ETA 07/0137

It. no. NEW č. p. NOVÉ	It. no. OLD č. p. STARÉ	Dimensions/ Rozmery [mm]		pcs. / package ks./bal.	€ / pcs. € / ks	kg / pcs. kg/ks.
		A	B			
SPF170L	02170 01	170	34,5	100	0,42	0,096
SPF170R	02171 01	170	34,5	100	0,42	0,096
SPF210L	02210 01	210	34,5	100	0,62	0,134
SPF210R	02211 01	210	34,5	100	0,62	0,134
SPF250L	02250 01	250	34,5	100	1,43	0,167
SPF250R	02251 01	250	34,5	100	1,43	0,167
SPF290L	02290 01	290	34,5	100	1,79	0,207
SPF290R	02291 01	290	34,5	100	1,79	0,207
SPF330L	02330 01	330	34,5	50	2,59	0,243
SPF330R	02331 01	330	34,5	50	2,59	0,243
SPF370L	02370 01	370	34,5	50	3,19	0,279
SPF370R	02371 01	370	34,5	50	3,19	0,279
SPF170LR-B	02172 00	170	34,5	40 Satz	0,41	0,096
SPF210LR-B	02212 00	210	34,5	40 Satz	0,58	0,134

Prices quoted are exclusive of VAT / Ceny sú uvedené bez DPH

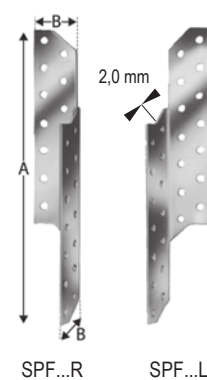

SPF...R SPF...L

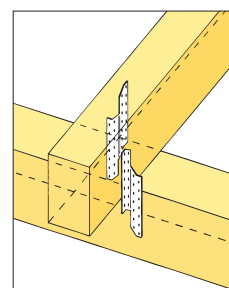

ETA 07/0137

It. no. NEW č. p. NOVÉ	It. no. OLD č. p. STARÉ	Dimensions/ Rozmery [mm]		pcs. / package ks./bal.	€ / pcs. € / ks	kg / pcs. kg/ks.
		A	B			
PFE170E-B	32170 00	170	20	40 set / sada	0,64	0,076
PFE210E-B	32210 00	210	20	40 set / sada	0,90	0,106

Prices quoted are exclusive of VAT / Ceny sú uvedené bez DPH

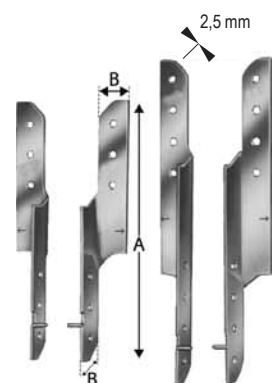

PFE170

PFE210

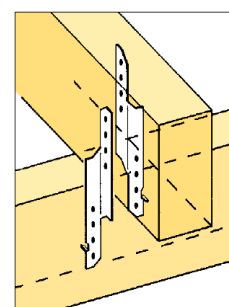



ETA 07/0137

It. no. NEW č. p. NOVÉ	It. no. OLD č. p. STARÉ	Dimensions/ Rozmery [mm]		pcs. / package ks./bal.	€ / pcs. € / ks	kg / pcs. kg/ks.
		A	B			
PFU170-B	32570 00	170	30	100	0,78	0,076
PFU210	32610 01	210	30	100	1,03	0,094
PFU250-B	32650 00	250	30	100	1,78	0,113

Prices quoted are exclusive of VAT / Ceny sú uvedené bez DPH

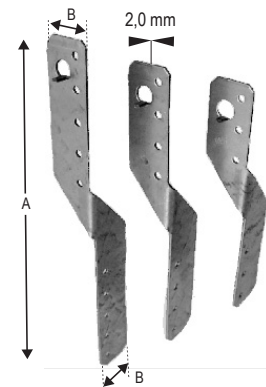

PFU

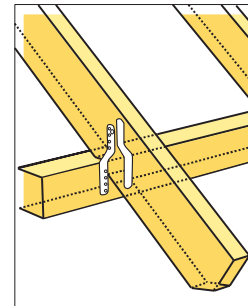

It. no. NEW č. p. NOVÉ	It. no. OLD č. p. STARÉ	Dimensions/ Rozmery [mm]					pcs. / package ks./bal.	€ / pcs. € / ks	kg / pcs. kg/ks.
		A	B	C	D	E			
TOP51-B	02800 00	285	57	51	20	60	50	5,23	0,180
TOL40-B	02840 00	253	57	40	20	23	50	4,88	0,124
TOL50-B	02850 00	248	57	51	20	23	50	4,88	0,124

Prices quoted are exclusive of VAT / Ceny sú uvedené bez DPH

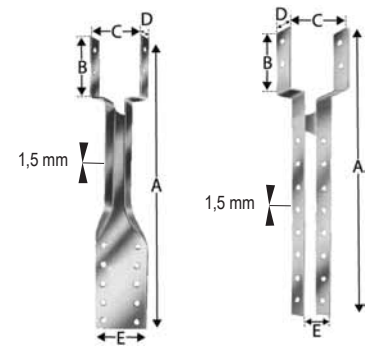

TOP

TOL

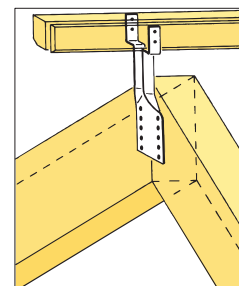



ETA 10/0044

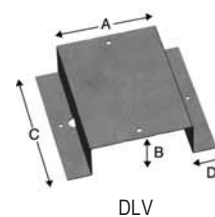

DLV

It. no. NEW č. p. NOVÉ	Dimensions/ Rozmery [mm]				pcs. / package ks./bal.	€ / pcs. € / ks	kg / pcs. kg/ks.
	A	B	C	D			
DLV60/40	62	40	140	25	50	1,94	0,215
DLV60/50	62	50	140	25	50	2,05	0,238
DLV100/40	102	40	140	25	50	2,26	0,261

Prices quoted are exclusive of VAT / Ceny sú uvedené bez DPH

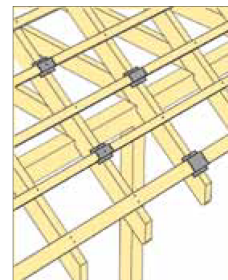

Windbracing strap/ Dierované pásy

BAN

It. no. NEW č. p. NOVÉ	It. no. OLD č. p. STARÉ	Dimensions/ Rozmery [mm]		pcs. / package ks./bal.	€ / pcs. € / ks	kg / pcs. kg/ks.
		A [mm]	B [m]			
BAN10203	27103 00	20	3	10	6,63	0,420
BAN102010	27110 00	20	10	10	16,82	1,525
BAN102025	27210 00	20	25	5	38,21	3,800
BAN152010	27115 00	20	10	10	21,70	2,285
BAN152025	27215 00	20	25	5	49,30	5,130

Prices quoted are exclusive of VAT / Ceny sú uvedené bez DPH

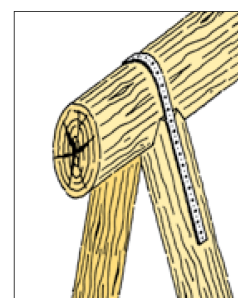
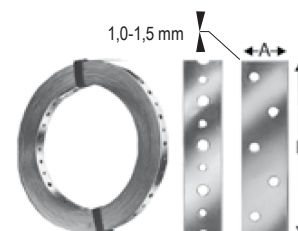

It. no. NEW č. p. NOVÉ	It. no. OLD č. p. STARÉ	Dimensions/ Rozmery [mm]			pcs. / package ks./bal.	€ / pcs. € / ks	kg / pcs. kg/ks.
		A [mm]	B [m]	T [mm]			
BAN202510	27120 00	25	10	2,0	4	33,52	3,980
BAN202525	27252 00	25	25	2,0	1	59,49	9,500
BAN154025	27414 00	40	25	1,5	1	78,44	10,800
BAN154050	27415 00	40	50	1,5	1	113,33	21,600
BAN204025	27419 00	40	25	2,0	1	74,51	14,000
BAN204050	27420 00	40	50	2,0	1	102,28	28,000
BAN304050	27430 00	40	50	3,0	1	295,45	46,200
BAN156050	27615 00	60	50	1,5	1	194,32	35,100
BAN206050	27620 00	60	50	2,0	1	180,52	46,200
BAN158025	27815 00	80	25	1,5	1	213,62	24,000
BAN208025	27820 00	80	25	2,0	1	239,26	29,700

Prices quoted are exclusive of VAT / Ceny sú uvedené bez DPH

Band unwinder/Odvíjač pásu

BANA

It. no. NEW č. p. NOVÉ	It. no. OLD č. p. STARÉ	pcs. / package ks./bal.	€ / pcs. € / ks	kg / pcs. kg/ks.
BANA2-B	27004 00	1	1344,55	23,500

Prices quoted are exclusive of VAT / Ceny sú uvedené bez DPH



BANA2

Windbracing strap/Montážne dierované pásy

FBAR / FBPR

It. no. NEW č. p. NOVÉ	It. no. OLD č. p. STARÉ	Dimensions/ Rozmery			pcs. / package ks./bal.	€ / pcs. € / ks	kg / pcs. kg/ks.
		A [mm]	T [mm]	B [m]			
FBAR12	27128 00	12	0,8	10	20	12,42	0,527
FBAR12B	27128 90	12	0,8	10	20	26,66	0,572
FBAR12W	27128 91	12	0,8	10	20	26,66	0,572
FBAR12R	27128 92	12	0,8	10	20	26,66	0,572
FBAR17	27178 00	17	0,8	10	20	17,12	0,783
FBAR17/25	27179 00	17	0,8	25	10	31,10	1,882
FBAR26-B	27261 00	26	1,2	10	10	35,06	1,646
FBPR16	27168 00	16	0,8	10	20	16,42	0,803
FBPR16B	27168 90	16	0,8	10	20	35,20	0,871
FBPR16W	27168 91	16	0,8	10	20	35,20	0,871
FBPR16R	27168 92	16	0,8	10	20	35,20	0,871

Prices quoted are exclusive of VAT / Ceny sú uvedené bez DPH

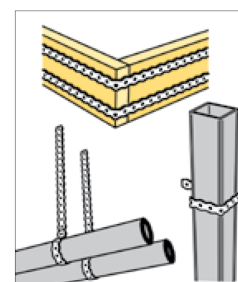
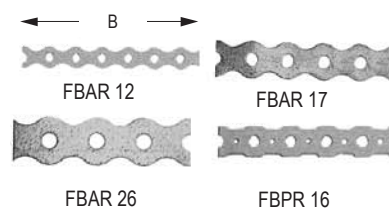

It. no. NEW č. p. NOVÉ	It. no. OLD č. p. STARÉ	pcs. / package ks./bal.	€ / pcs. € / ks	kg / pcs. kg/ks.
BANSTR-B	27000 00	3	93,35	1,000
BANSTRS-B	27002 00	1	328,15	2,300

Prices quoted are exclusive of VAT / Ceny sú uvedené bez DPH



BANSTR



BANSTRS

Windbracking system/Zavetrovací systém

BNSP



ETA 10/0440

It. no. NEW č. p. NOVÉ	It. no. OLD č. p. STARÉ	Dimensions/ Rozmery [mm]			pcs. / package ks./bal.	€ / pcs. € / ks	kg / pcs. kg/ks.
		A	B	C			
BNSP25-B	27025 00	265-305	25	25	4	30,52	0,482
BNSP40-B	27040 00	300-350	40	28	4	32,62	0,700
BNSP60-B	27060 00	300-350	60	35	4	43,11	1,325
BNSP80-B	27080 00	300-360	80	35	4	62,11	1,779
BNSP4060B-B	27050 00	350-400	60	35	4	50,08	1,597
BNSP25B-B	27030 00	265-305	25	25	4	28,79	0,528

Prices quoted are exclusive of VAT / Ceny sú uvedené bez DPH

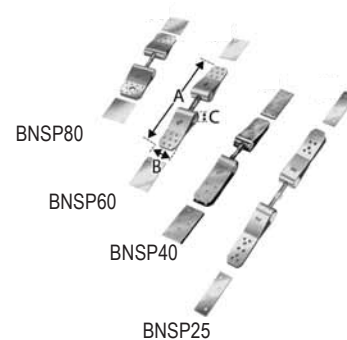

BNSP80

BNSP60

BNSP40

BNSP25



BNSP 25B

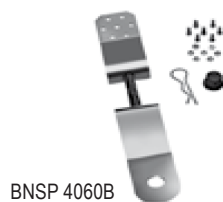

BNSP 4060B

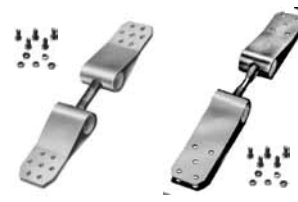

BNSP60

BNSP40B



ETA 10/0440

It. no. NEW č. p. NOVÉ	It. no. OLD č. p. STARÉ	Dimensions/ Rozmery [mm]			pcs. / package ks./bal.	€/ pcs. €/ ks	kg / pcs. kg/ks.
		A	B	C			
BNKK25-B	27929 00	125	36	2+2+2=6	4	10,74	0,167
BNKK40/60-B	27949 00	157	60	2+3+2=7	4	13,37	0,364

Prices quoted are exclusive of VAT / Ceny sú uvedené bez DPH



BNKK

It. no. NEW č. p. NOVÉ	It. no. OLD č. p. STARÉ	Dimensions/ Rozmery [mm]			pcs. / package ks./bal.	€/ pcs. €/ ks	kg / pcs. kg/ks.
		A	B	T			
BNK25-B	27926 00	200	125	2	40	7,68	0,290
BNK40/60-B	27946 00	290	190	2	10	9,86	0,575

Prices quoted are exclusive of VAT / Ceny sú uvedené bez DPH

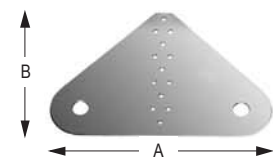

BNK25

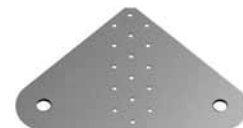

BNK40/60

It. no. NEW č. p. NOVÉ	It. no. OLD č. p. STARÉ	Dimensions/ Rozmery [mm]				pcs. / package ks./bal.	€/ pcs. €/ ks	kg / pcs. kg/ks.
		A	B	C	T			
BNF25-B	27920 00	218	128	15	2	19,89	0,860	
BNG25-B	27923 00	285	153	50	3	26,13	1,800	
BNF40-B	27940 00	289	198	15	2	26,19	1,368	
BNG60-B	27943 00	289	198	69	3	35,70	2,557	

Prices quoted are exclusive of VAT / Ceny sú uvedené bez DPH

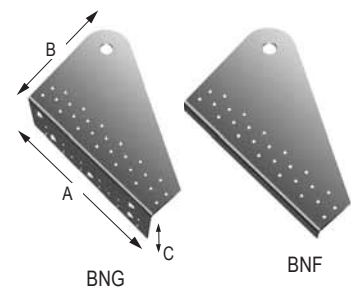

BNG

BNF



ETA 10/0440

It. no. NEW č. p. NOVÉ	It. no. OLD č. p. STARÉ	Dimensions/ Rozmery [mm]				pcs. / package ks./bal.	€ / pcs. € / ks	kg / pcs. kg/ks.
		A	B	C	T			
BNW1	27950 00	238	216	40	3+3=6	8	84,28	2,125
BNW2	27951 00	238	216	40	3+3=6	8	103,03	2,700

Prices quoted are exclusive of VAT / Ceny sú uvedené bez DPH



BNW1

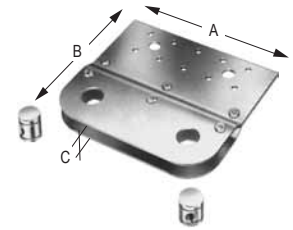

BNW2

It. no. NEW č. p. NOVÉ	It. no. OLD č. p. STARÉ	Dimensions/ Rozmery [mm]				pcs. / package ks./bal.	€ / pcs. € / ks	kg / pcs. kg/ks.
		A	B	C	I			
BNWA	27953 00	140	60	35	165	8	33,21	0,813

Prices quoted are exclusive of VAT / Ceny sú uvedené bez DPH



BNWA

It. no. NEW č. p. NOVÉ	It. no. OLD č. p. STARÉ	Length/Dĺžka [mm]		pcs. / package ks./bal.	€ / pcs. € / ks	kg / pcs. kg/ks.
		Threaded rod/ Závitové tyče M16	Tension nut/ Napínací matka			
BNWM 16-B	27954 00	140	120	16	38,74	0,550
BNWM 12-B	27955 00	140	120	16	38,74	0,575

Prices quoted are exclusive of VAT / Ceny sú uvedené bez DPH



BNWM

It. no. NEW č. p. NOVÉ	It. no. OLD č. p. STARÉ	Dimensions/ Rozměry [mm]			pcs. / package ks./bal.	€ / pcs. € / ks	kg / pcs. kg/ks.
		A	B	T			
NP15/40/120	NP15040120	40	120	1,5	50	0,45	0,053
NP15/40/160	NP15040160	40	160	1,5	50	0,52	0,072
NP15/50/200	NP15050200	50	200	1,5	50	0,68	0,112
NP15/60/140	15525 01	60	140	1,5	50	0,57	0,094
NP15/60/160	15530 01	60	160	1,5	50	0,76	0,104
NP15/60/200	15537 01	60	200	1,5	50	0,78	0,135
NP15/60/240	NP15060240	60	240	1,5	50	0,94	0,162
NP15/60/300	15540 01	60	300	1,5	50	1,34	0,200
NP15/60/340	15536 01	60	340	1,5	50	1,51	0,230
NP15/60/420	15538 01	60	420	1,5	50	1,78	0,280
NP15/60/500	15539 01	60	500	1,5	50	2,22	0,337
NP15/80/140	15541 01	80	140	1,5	50	0,83	0,130
NP15/80/200	NP15080200	80	200	1,5	50	1,27	0,178
NP15/80/240	15546 01	80	240	1,5	50	1,27	0,220
NP15/80/280	15550 01	80	280	1,5	50	1,60	0,250
NP15/80/300	15555 01	80	300	1,5	50	1,67	0,264
NP15/80/340	15560 01	80	340	1,5	50	1,94	0,304
NP15/100/140	15571 01	100	140	1,5	50	0,98	0,160
NP15/100/200	NP15100200	100	200	1,5	50	1,28	0,222
NP15/100/220	15572 01	100	220	1,5	50	1,57	0,240
NP15/100/240	15573 01	100	240	1,5	50	1,72	0,264
NP15/100/300	15574 01	100	300	1,5	50	2,13	0,330
NP15/100/340	15576 01	100	340	1,5	50	2,41	0,370
NP15/120/240	NP15120240	120	240	1,5	50	2,15	0,320
NP15/120/260	15582 01	120	260	1,5	50	2,20	0,341
NP15/120/300	NP15120300	120	300	1,5	25	2,61	0,380
NP15/140/200	15585 01	140	200	1,5	50	2,02	0,312
NP15/140/300	15593 01	140	300	1,5	25	3,05	0,460
NP15/160/260	15620 01	160	260	1,5	25	2,95	0,452
NP15/160/400	NP15160400	160	400	1,5	20	4,69	0,710
NP15/180/220	15631 01	180	220	1,5	25	2,88	0,440
NP20/40/120	20525 01	40	120	2,0	50	0,35	0,071
NP20/40/160	20530 01	40	160	2,0	50	0,50	0,094
NP20/50/200	20535 01	50	200	2,0	50	0,74	0,145
NP20/60/140	20540 01	60	140	2,0	50	0,57	0,123
NP20/60/200	20545 01	60	200	2,0	50	0,70	0,176
NP20/60/240	20550 01	60	240	2,0	50	0,95	0,215
NP20/80/200	20555 01	80	200	2,0	50	0,91	0,232
NP20/80/240	20560 01	80	240	2,0	50	1,10	0,292
NP20/80/300	20565 01	80	300	2,0	50	2,34	0,350
NP20/100/140	20570 01	100	140	2,0	50	0,95	0,204
NP20/100/200	20575 01	100	200	2,0	50	1,27	0,296
NP20/100/240	20580 01	100	240	2,0	50	1,66	0,348
NP20/100/260	20585 01	100	260	2,0	50	1,85	0,384
NP20/100/300	20590 01	100	300	2,0	25	3,04	0,450
NP20/100/400	20592 01	100	400	2,0	25	5,01	0,596
NP20/100/500	20594 01	100	500	2,0	25	4,15	0,745
NP20/120/200	20595 01	120	200	2,0	50	1,68	0,348
NP20/120/240	20600 01	120	240	2,0	50	3,00	0,414
NP20/120/260	20605 01	120	260	2,0	25	2,17	0,476
NP20/120/300	20610 01	120	300	2,0	25	2,15	0,532
NP20/120/400	20614 01	120	400	2,0	25	3,31	0,689
NP20/140/400	20615 01	140	400	2,0	25	6,95	0,828
NP20/160/300	20612 01	160	300	2,0	25	4,47	0,686
NP20/160/400	20617 01	160	400	2,0	20	4,69	0,930
NP20/200/300	20620 01	200	300	2,0	20	7,16	0,888
NP20/650/1200	NP20/650/1200	650	1200	2,0	1	55,62	12,250
NP25/650/1200	NP25/650/1200	650	1200	2,5	1	81,18	15,310
NP30/650/1500	NP30/650/1500	650	1500	3,0	1	100,71	23,000

Prices quoted are exclusive of VAT / Ceny sú uvedené bez DPH

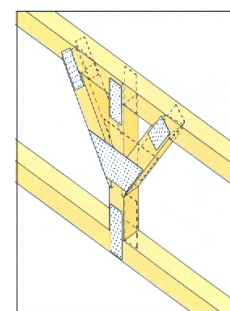
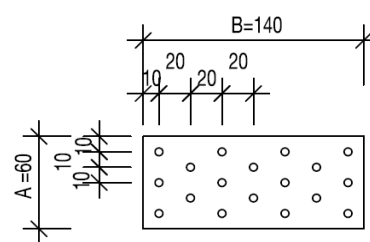
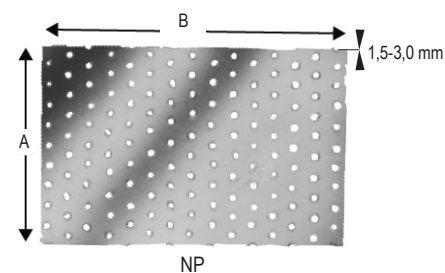

It. no. NEW č. p. NOVÉ	It. no. OLD č. p. STARÉ	Dimensions/ Rozmery [mm]			pcs. / package ks./bal.	€ / pcs. € / ks	kg / pcs. kg/ks.
		A	B	T			
NP20/40/1200	20040 01	40	1200	2,0	30	5,50	0,703
NP20/60/1200-B	20060 00	60	1200	2,0	20	8,31	1,050
NP20/80/1200-B	20080 00	80	1200	2,0	15	9,94	1,387
NP20/100/1200-B	20100 00	100	1200	2,0	10	11,96	1,710
NP20/120/1200-B	20120 00	120	1200	2,0	10	14,94	2,070
NP20/140/1200-B	20140 00	140	1200	2,0	10	18,41	2,388
NP20/160/1200-B	20160 00	160	1200	2,0	5	20,58	2,772
NP20/180/1200-B	20180 00	180	1200	2,0	5	24,45	3,108
NP20/200/1200-B	20200 00	200	1200	2,0	5	25,91	3,461
NP20/220/1200-B	20220 00	220	1200	2,0	5	29,45	3,802
NP20/240/1200-B	20240 00	240	1200	2,0	5	33,32	4,147
NP20/260/1200-B	20260 00	260	1200	2,0	5	36,63	4,493
NP20/280/1200-B	20280 00	280	1200	2,0	5	38,97	4,838
NP20/300/1200-B	20300 00	300	1200	2,0	5	41,31	5,184
NP25/40/1200-B	25040 00	40	1200	2,5	20	7,63	0,877
NP25/60/1200-B	25060 00	60	1200	2,5	15	11,42	1,320
NP25/80/1200-B	25080 00	80	1200	2,5	10	15,16	1,785
NP25/100/1200-B	25100 00	100	1200	2,5	10	18,70	2,185
NP25/120/1200-B	25120 00	120	1200	2,5	10	21,60	2,610
NP25/140/1200-B	25140 00	140	1200	2,5	5	24,27	3,092
NP25/160/1200-B	25160 00	160	1200	2,5	5	28,05	3,384
NP25/180/1200-B	25180 00	180	1200	2,5	5	31,38	3,972
NP25/200/1200-B	25200 00	200	1200	2,5	5	34,44	4,308
NP25/220/1200-B	25220 00	220	1200	2,5	1	38,26	4,735
NP25/240/1200-B	25240 00	240	1200	2,5	1	42,25	5,264
NP25/260/1200-B	25260 00	260	1200	2,5	1	45,46	5,594
NP25/280/1200-B	25280 00	280	1200	2,5	1	49,25	6,024
NP25/300/1200-B	25300 00	300	1200	2,5	1	52,20	6,454

Prices quoted are exclusive of VAT / Ceny sú uvedené bez DPH

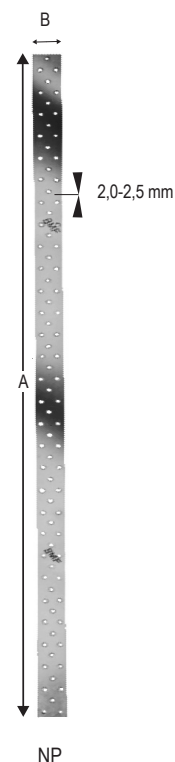

Flat nail plates/Ploché spojky

FLV

It. no. NEW č. p. NOVÉ	It. no. OLD č. p. STARÉ	Dimensions/ Rozmery [mm]		pcs. / package ks./bal.	€ / pcs. € / ks	kg / pcs. kg/ks.
		A	B			
FLV40/100	FLV40/100	40	100	100	0,68	0,080
FLV40/180	FLV40/180	40	180	100	1,00	0,173
FLV55/135	FLV55/135	55	135	100	0,84	0,119

Prices quoted are exclusive of VAT / Ceny sú uvedené bez DPH

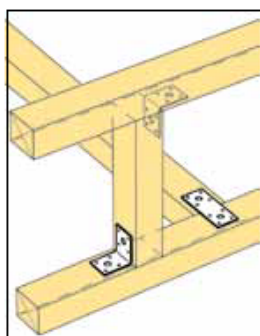
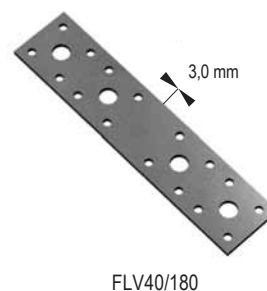
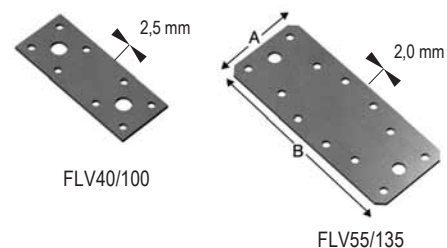

It. no. NEW č. p. NOVÉ	Dimensions/ Rozmery [mm]		pcs. / package ks./bal.	€ / pcs. € / ks	kg / pcs. kg/ks.
	A	B			
MP24	51	102	100	0,51	0,040
MP36	76	152	100	0,94	0,090

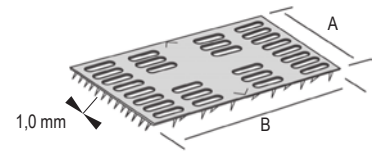

Prices quoted are exclusive of VAT / Ceny sú uvedené bez DPH



ETA 07/0317

It. no. NEW č. p. NOVÉ	It. no. OLD č. p. STARÉ	Dimensions/ Rozmery [mm]					pcs. / package ks./bal.	€ / pcs. € / ks	kg / pcs. kg/ks.
		A	B	C	D	E			
SFN-B	13001 00	177	139	53	53	39	25	6,02	0,680
SFM-B	13002 00	260	169	73	73	91	10	11,24	1,340
SFH-B	13003 00	270	159	45	60	27	20	5,38	0,507
SFHM-B	13004 00	270	140	108	75	50	20	6,13	0,620
SFHS-B	13005 00	260	140	108	75	50	10	26,39	1,620
SHLM-B	13014 00	360	280	53	-	-	1	15,10	2,830
SHLS-B	13015 00	500	387	52	-	-	1	38,19	5,200

Prices quoted are exclusive of VAT / Ceny sú uvedené bez DPH

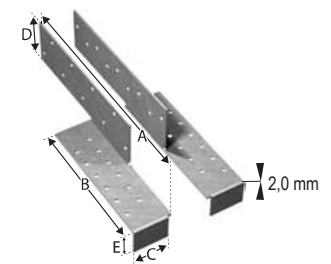

SFH

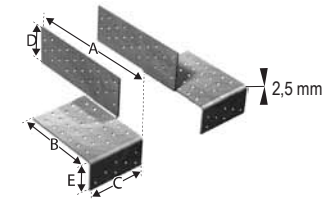

SFM

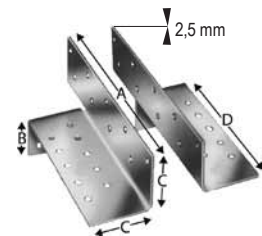

SFN

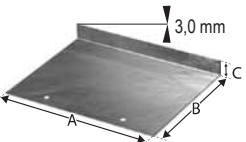

SHLM

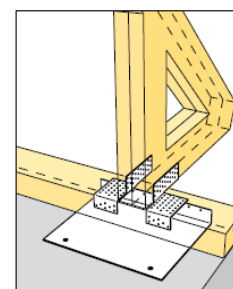
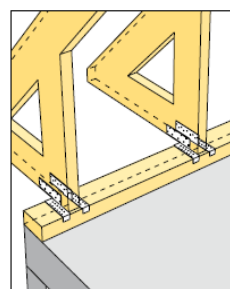
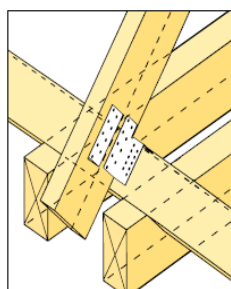



ETA 07/0317

It. no. NEW č. p. NOVÉ	It. no. OLD č. p. STARÉ	Dimensions/ Rozmery [mm]				pcs. / package ks./bal.	€ / pcs. € / ks	kg / pcs. kg/ks.
		A	B	C	D			
SHB80G-B	24080 00	84	170	220	140	15	23,12	1,232
SHB100G-B	24100 00	104	170	240	140	15	25,74	1,432
SHB120G-B	24120 00	124	170	260	140	10	28,88	1,635
SHH80G-B	23080 00	84	300	140	-	15	20,19	1,240
SHH100G-B	23100 00	104	280	140	-	10	21,95	1,360
SHH120G-B	23120 00	124	260	140	-	10	24,56	1,545

Prices quoted are exclusive of VAT / Ceny sú uvedené bez DPH

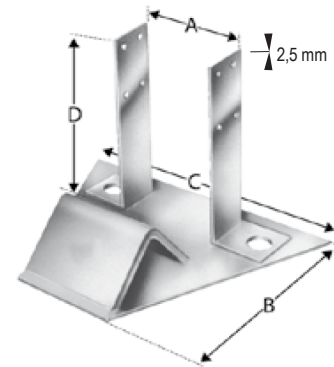

SHB

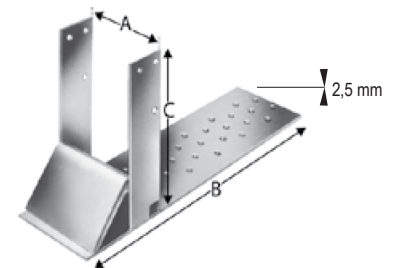

SHH

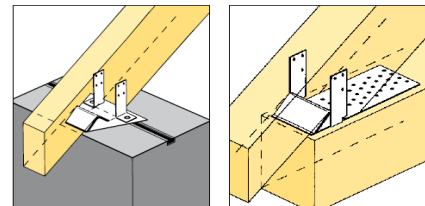

Cantilever bracket/Gerberova spojka

GERB



ETA 07/0053

It. no. NEW č. p. NOVÉ	It. no. OLD č. p. STARÉ	Dimensions/ Rozmery [mm]			pcs. / package ks./bal.	€ / set (2pcs). € / sada (2 ks)	kg / pcs. kg/ks.
		A	B	C			
GERB125-B	11125 00	129	90	27	25	5,95	0,496
GERB150-B	11150 00	154	90	29	25	5,51	0,588
GERB160-B	11160 00	160	90	30	25	5,51	0,616
GERB175-B	11175 00	179	90	33	25	6,13	0,674
GERB180-B	11180 00	180	90	33	25	6,13	0,676
GERB200DE-B	11201 00	201	90	33	25	6,71	0,736
GERB220-B	11220 00	220	90	34	25	7,51	0,800

Prices quoted are exclusive of VAT / Ceny sú uvedené bez DPH

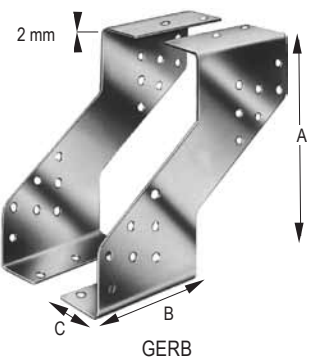

GERB

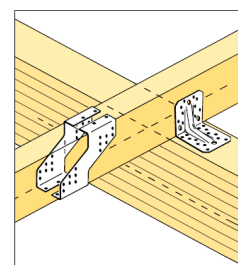



ETA 07/0053

It. no. NEW č. p. NOVÉ	It. no. OLD č. p. STARÉ	Dimensions/ Rozmery [mm]			pcs. / package ks./bal.	€ / pcs. € / ks	kg / pcs. kg/ks.
		A	B	C			
GERG120/180-B	12218 00	182	90	122	10	12,07	0,792
GERG120/200-B	12220 00	202	90	122	10	12,52	0,850
GERG140/200-B	12420 00	202	90	142	10	☞	0,878
GERG120/220-B	12222 00	222	90	122	10	13,37	0,907
GERG140/220-B	12422 00	222	90	142	10	☞	0,936
GERG160/220-B	12622 00	222	90	162	10	☞	0,965
GERG120/240-B	12224 00	242	90	122	10	14,22	0,965
GERG140/240-B	12424 00	242	90	142	10	14,66	0,994
GERG160/240-B	12624 00	242	90	162	10	☞	1,022
GERG120/260-B	12226 00	262	90	122	10	☞	1,022
GERG140/260-B	12426 00	262	90	142	10	☞	1,051
GERG160/260-B	12626 00	262	90	162	*	☞	1,080

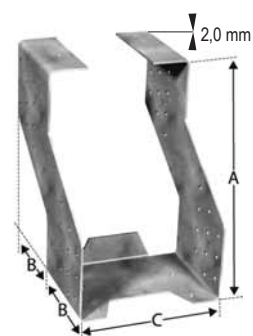

GERG

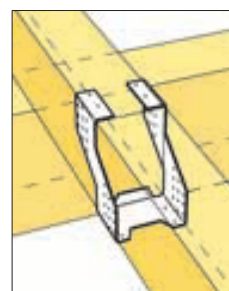

6

☞ Price and delivery time on request / Cena a doba dodania na vyžiadanie
Prices quoted are exclusive of VAT / Ceny sú uvedené bez DPH

It. no. NEW č. p. NOVÉ	It. no. OLD č. p. STARÉ	Dimensions/ Rozmery [mm]			pcs. / package ks./bal.	€ / set (2 pcs.) € / sada (2 ks)	kg / pcs. kg/ks.
		A	B	C			
GERW90-B	28090 00	90	140	20	25	4,63	0,490
GERW120-B	28120 00	120	180	20	25	8,68	0,806
GERW140-B	28140 00	140	180	20	20	9,80	0,922
GERW160-B	28160 00	160	180	20	20	10,62	1,037
GERW180-B	28180 00	180	180	20	15	12,03	1,152
GERW200-B	28200 00	200	180	20	15	13,21	1,267
GERW220-B	28220 00	220	180	20	15	14,20	1,310
GERW240-B	28240 00	240	180	20	15	15,69	1,469
GERW260-B	28260 00	260	180	20	10	16,89	1,568
GERW280-B ¹⁾	–	280	180	20	–	☞	–
GERW300-B ¹⁾	–	300	180	20	–	☞	–
GERW320-B ¹⁾	–	320	180	20	–	☞	–
GERW340-B ¹⁾	–	340	180	20	–	☞	–
GERW360-B ¹⁾	–	360	180	20	–	☞	–

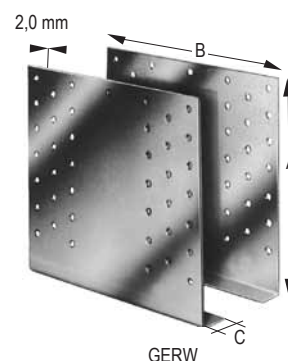

GERW

1) Currently without ETA-CE / Momentálne bez ETA-CE

☞ Price and delivery time on request / Cena a doba dodania na vyžiadanie
Prices quoted are exclusive of VAT / Ceny sú uvedené bez DPH



ETA 07/0285

It. no. NEW č. p. NOVÉ	It. no. OLD č. p. STARÉ	Dimensions/ Rozmery [mm]						pcs. / package ks./bal.	€ / pcs. € / ks	kg / pcs. kg/ks.
		A	B	C	D	E	F			
CMR	44150 00	115-165	100	600	250	300	60	1	188,46	20,350

Prices quoted are exclusive of VAT / Ceny sú uvedené bez DPH

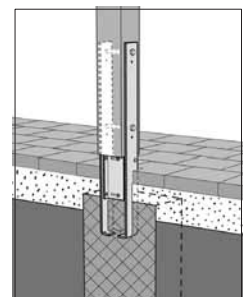
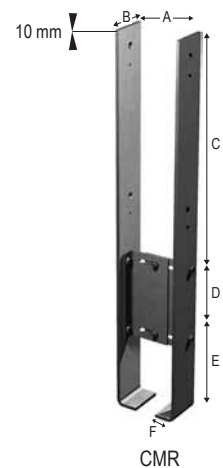

ETA 07/0285

It. no. NEW č. p. NOVÉ	It. no. OLD č. p. STARÉ	Dimensions/ Rozmery [mm]						pcs. / package ks./bal.	€ / pcs. € / ks	kg / pcs. kg/ks.
		A	B	C	D	E	F			
CPB40	CPB40	105	40	120	190-250	160	90	5	69,37	4,100
CPS40	CPS40	105	40	120	450	70	70	5	56,18	3,600
BH54	Blendhüse							5	11,35	0,660
BTBS40	Bohrschablone							1		1,100

Price and delivery time on request / Cena a doba dodania na vyžiadanie
Prices quoted are exclusive of VAT / Ceny sú uvedené bez DPH

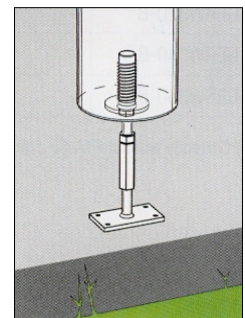
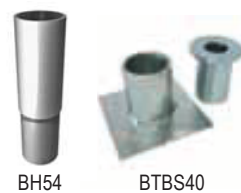
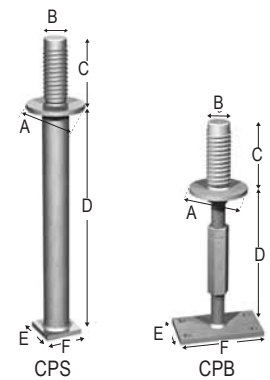

It. no. NEW č. p. NOVÉ	It. no. OLD č. p. STARÉ	Dimensions/ Rozmery [mm]					pcs. / package ks./bal.	€ / pcs. € / ks	kg / pcs. kg/ks.
		A	B	C	D	E			
PA70G	26070 01	70	70	250	50	16	25	7,04	0,598
PA90G	26090 01	90	90	250	50	20	20	11,42	1,017

Prices quoted are exclusive of VAT / Ceny sú uvedené bez DPH

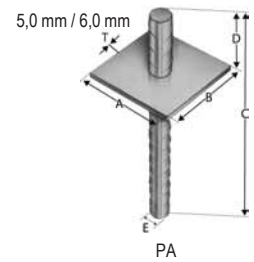

PA

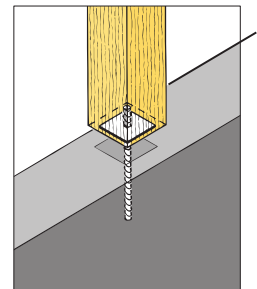

It. no. NEW č. p. NOVÉ	It. no. OLD č. p. STARÉ	Dimensions/ Rozmery [mm]					pcs. / package ks./bal.	€ / pcs. € / ks	kg / pcs. kg/ks.
		A	B	C	D	E			
PB40G	26091 01	45	70	121	250	16	25	7,92	0,666
PB70G	26092 01	70	70	125	250	16	20	10,46	0,930
PBK60G	42105 01	70	60	92	450	16	25	6,85	0,632
PBE60G-B	42005 00	70	60	92	200	16	15	11,36	1,035

Prices quoted are exclusive of VAT / Ceny sú uvedené bez DPH

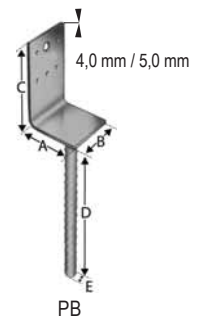

PB

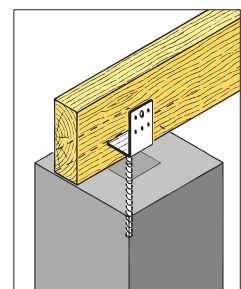

It. no. NEW č. p. NOVÉ	It. no. OLD č. p. STARÉ	Dimensions/ Rozmery [mm]					pcs. / package ks./bal.	€ / pcs. € / ks	kg / pcs. kg/ks.
		A	B	C	D	E			
PDKS48/40G	41248 01	48	40	88,5	343-405	–	10	25,76	1,070
PDKS98/60G	41298 01	98	60	88,5	343-405	–	10	27,65	1,310
PDKB48/40G	41348 01	48	40	88,5	178-240	90	10	32,03	1,060
PDKB98/60G	41398 01	98	60	88,5	178-240	90	10	33,64	1,300

Prices quoted are exclusive of VAT / Ceny sú uvedené bez DPH

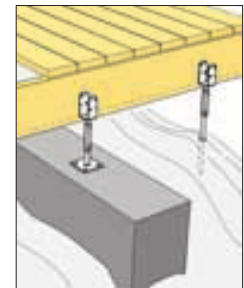
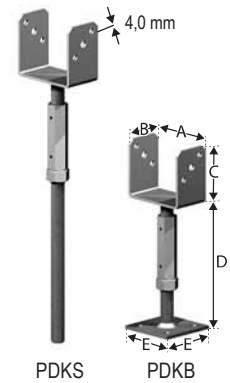

ETA 07/0285

It. no. NEW č. p. NOVÉ	Dimensions/ Rozmery [mm]						pcs. / package ks./bal.	€ / pcs. € / ks	kg / pcs. kg/ks.
	A	B	C	D	E	F			
PGS24/130	80	24	125	130-195	180	100	6	38,90	2,650
PGS24/180	80	24	125	180-245	180	100	6	40,08	2,800
PGS24/230	80	24	125	230-295	180	100	6	41,73	3,070
PGS24/280	80	24	125	280-345	180	100	6	44,12	3,250

Prices quoted are exclusive of VAT / Ceny sú uvedené bez DPH

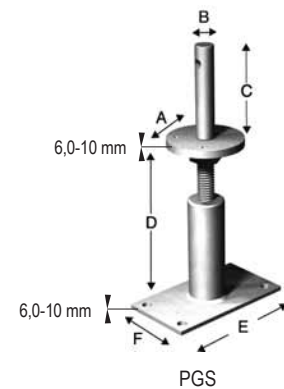

It. no. NEW č. p. NOVÉ	It. no. OLD č. p. STARÉ	Dimensions/ Rozmery [mm]			pcs. / package ks./bal.	€ / pcs. € / ks	kg / pcs. kg/ks.
		A	B	C			
PH300G	17730 01	300	30	25	25	3,53	0,349
PH350G	17735 01	350	30	25	25	4,74	0,410
PH450G	17745 01	450	31	25	7,46	0,710	

Prices quoted are exclusive of VAT / Ceny sú uvedené bez DPH



PH

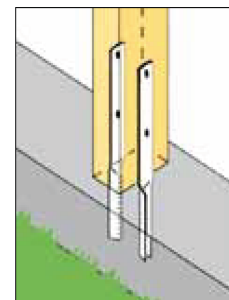

ETA 06/0270

It. no. NEW č. p. NOVÉ	It. no. OLD č. p. STARÉ	Dimensions/ Rozmery [mm]					pcs. / package ks./bal.	€ / pcs. € / ks	kg / pcs. kg/ks.
		A	B	C	D	E			
PIG-B	26000 00	90	60	110	260	20	10	21,32	1,597
PILG	31000 00	90	60	110	510	38	10	36,51	1,920

Prices quoted are exclusive of VAT / Ceny sú uvedené bez DPH

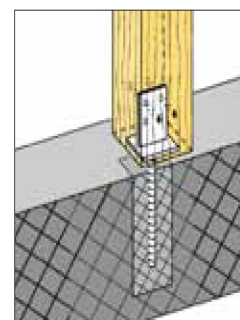
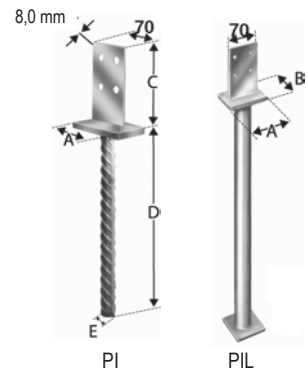

7



ETA 07/0285

It. no. NEW č. p. NOVÉ	It. no. OLD č. p. STARÉ	Dimensions/ Rozmery [mm]					pcs. / package ks./bal.	€ / pcs. € / ks	kg / pcs. kg/ks.
		A	B	C	D	E			
PIS70G-B	31965 00	100	80	313	70	70	8	35,17	2,253
PISB160G-B	31960 00	100	80	168	100	160	5	43,48	2,861
PISB260G-B	31970 00	100	80	168	100	260	4	54,42	3,714
PISMAXIG-B	31975 00	120	120	323	90	90	1	98,66	5,350
PISBMAXIG-B	31980 00	120	120	148	200	200	1	119,00	8,080

Prices quoted are exclusive of VAT / Ceny sú uvedené bez DPH

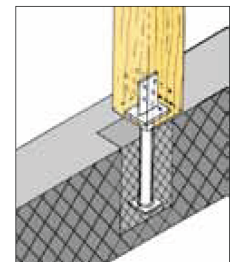
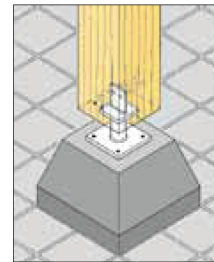
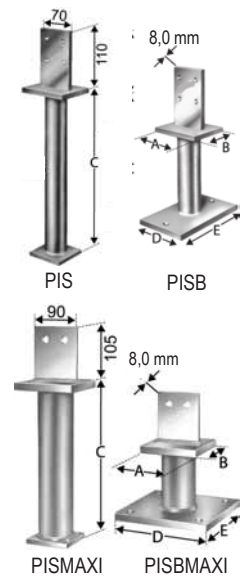

ETA 07/0285

It. no. NEW č. p. NOVÉ	It. no. OLD č. p. STARÉ	Dimensions/ Rozmery [mm]						pcs. / package ks./bal.	€ / pcs. € / ks	kg / pcs. kg/ks.
		A	B	C	D	E	F			
PJIBG	43000 01	70	110	163-213	120	90	60	5	50,07	2,400
PJISG	43001 01	70	110	355-405	-	90	60	4	45,67	1,900

Prices quoted are exclusive of VAT / Ceny sú uvedené bez DPH

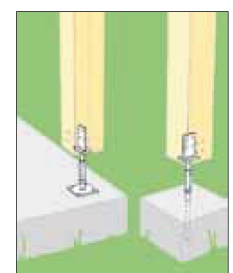
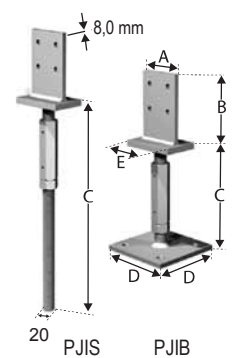



ETA 07/0285

It. no. NEW č. p. NOVÉ	It. no. OLD č. p. STARÉ	Dimensions/ Rozmery [mm]				pcs. / package ks./bal.	€ / pcs. € / ks	kg / pcs. kg/ks.
		A	B	C	D			
PJPSG	43011 01	80	120	355-405	20	10	52,90	1,400
PJPBG	43010 01	80	120	163-213	20	5	57,29	1,900

Prices quoted are exclusive of VAT / Ceny sú uvedené bez DPH

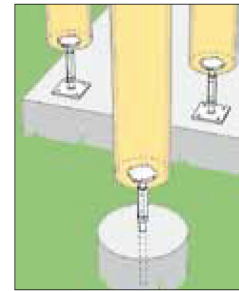
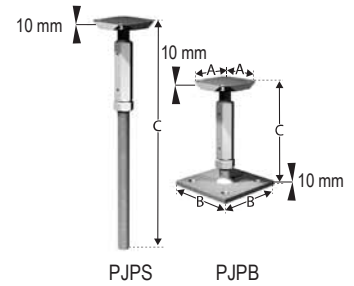

ETA 07/0285

It. no. NEW č. p. NOVÉ	It. no. OLD č. p. STARÉ	Dimensions/ Rozmery [mm]				pcs. / package ks./bal.	€ / pcs. € / ks	kg / pcs. kg/ks.
		A	B	C	D			
PL80/70G-B	31807 00	80	70	126	500	10	29,40	1,940
PL100/70G-B	31107 00	100	70	126	500	5	29,65	1,995
PL90/90G-B	31909 00	90	90	141	500	5	33,79	2,333
PL100/90G-B	31109 00	100	90	136	500	5	33,79	2,333
PL120/90G-B	31120 00	120	90	126	500	5	32,99	2,333
PL140/90G-B	31140 00	140	90	126	500	5	33,79	2,404

Prices quoted are exclusive of VAT / Ceny sú uvedené bez DPH

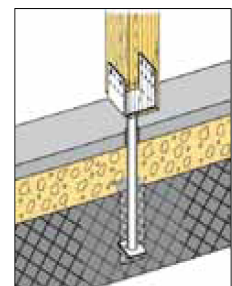
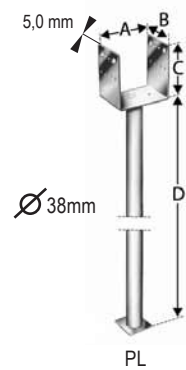



ETA 07/0285

It. no. NEW č. p. NOVÉ	It. no. OLD č. p. STARÉ	Dimensions/ Rozmery [mm]					pcs. / package ks./bal.	€ / pcs. € / ks	kg / pcs. kg/ks.
		A	B	C	D	E			
PLB60/65G-B	40405 00	60	65	100	90	16	10	22,37	0,790
PLB60/165G-B	40410 00	60	165	100	90	16	10	23,84	1,050
PLB80/90G-B	40420 00	80	90	100	90	16	10	23,01	0,900
PLB80/190G-B	40430 00	80	190	100	90	16	10	24,48	1,095
PLS60/65G-B	40305 00	60	65	270	-	16	10	18,21	0,700
PLS60/165G-B	40310 00	60	165	270	-	16	10	19,61	0,915
PLS80/90G-B	40320 00	80	90	270	-	16	10	18,84	0,800
PLS80/190G-B	40330 00	80	190	270	-	16	10	20,28	1,000

Prices quoted are exclusive of VAT / Ceny sú uvedené bez DPH

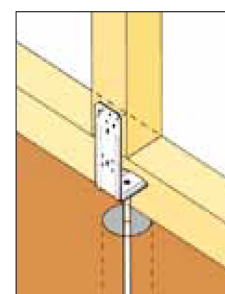
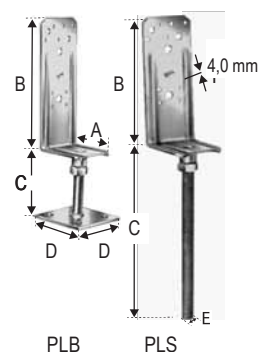

ETA 07/0285

It. no. NEW č. p. NOVÉ	It. no. OLD č. p. STARÉ	Dimensions/ Rozmery [mm]					pcs. / package ks./bal.	€ / pcs. € / ks	kg / pcs. kg/ks.
		A	B	C	D	E			
PPA100	40810 01	100	100	100	130	130	10	25,07	1,100
PPA150	40815 01	100	150	100	130	130	10	26,46	1,300
PPRC	40800 01	100	100-150	100	130	130	10	41,29	1,500

Prices quoted are exclusive of VAT / Ceny sú uvedené bez DPH

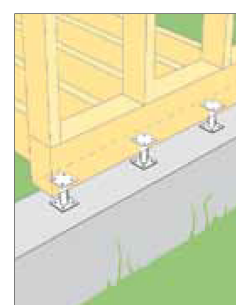
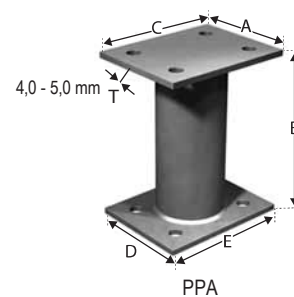



ETA 07/0285

It. no. NEW č. p. NOVÉ	It. no. OLD č. p. STARÉ	Dimensions/ Rozmery [mm]					pcs. / package ks./bal.	€/ pcs. €/ ks.	kg / pcs. kg/ks.
		A	B	C	D	E			
PPB70G	40600 01	70	105	90	16	-	20	12,19	0,650
PPB75G	40603 01	80	97	90	20	-	20	12,17	0,909
PPB80G-B	40605 00	80	208	140	20	100	10	21,86	1,850
PPS80G-B	40610 00	80	350	-	20	-	10	19,92	1,200

Prices quoted are exclusive of VAT / Ceny sú uvedené bez DPH

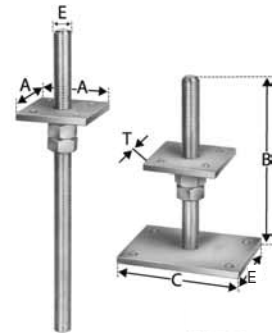
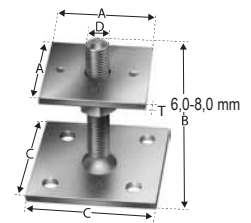

PPS 80

PPB 80

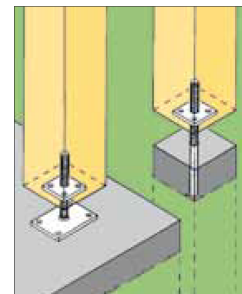



ETA 07/0285

It. no. NEW č. p. NOVÉ	It. no. OLD č. p. STARÉ	Dimensions/ Rozmery [mm]					pcs. / package ks./bal.	€/ pcs. €/ ks	kg / pcs. kg/ks.
		A	B	C	D	E			
PPD48/40G	26484 01	48	40	126	250	16	20	13,62	0,850
PPD50/40G	26504 01	50	40	125	250	16	20	13,74	0,850
PPD73/40G	26734 01	73	40	126	250	16	20	14,22	0,925
PPD100/40G	26104 01	100	40	125	250	16	20	14,94	0,984
PPD98/60G	26986 01	98	60	127	250	16	15	17,94	1,175
PPD73/70G	26737 01	73	70	130	250	16	15	19,24	1,330
PPD75/70G	26757 01	75	70	129	250	16	15	19,24	1,330
PPD80/70G-B	26807 00	80	70	126	250	16	15	18,18	1,330
PPD100/70G	26107 01	100	70	126	250	16	10	18,28	1,400
PPD90/90G	26909 01	90	90	141	250	20	10	25,76	1,910
PPD100/90G	26109 01	100	90	136	250	20	10	25,76	1,910
PPD115/90G	26115 01	115	90	129	250	20	10	27,37	1,910
PPD120/90G	26120 01	120	90	126	250	20	10	25,06	1,910
PPD123/90G	26123 01	123	90	125	250	20	10	27,24	1,910
PPD125/90G-B	26125 00	125	90	124	250	20	10	27,24	1,910
PPD140/90G	26140 01	140	90	126	250	20	10	25,44	1,990
PPD148/90G	26148 01	148	90	122	250	20	10	27,79	1,990

Prices quoted are exclusive of VAT / Ceny sú uvedené bez DPH

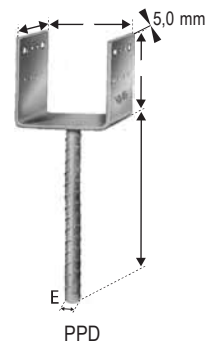

ETA 07/0285

It. no. NEW č. p. NOVÉ	It. no. OLD č. p. STARÉ	Dimensions/ Rozmery [mm]				pcs. / package ks./bal.	€/ pcs. €/ ks	kg / pcs. kg/ks.
		A	B	C	D			
PP80G	43020 01	80	260	-	20	15	29,10	1,100
PPL80G	43021 01	80	510	70	38	10	37,64	1,550

Prices quoted are exclusive of VAT / Ceny sú uvedené bez DPH

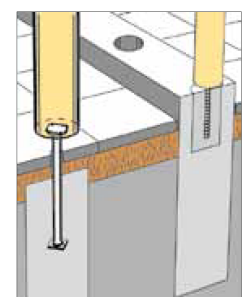
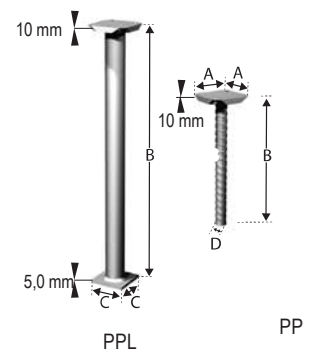

It. no. NEW č. p. NOVÉ	It. no. OLD č. p. STARÉ	Dimensions/ Rozmery [mm]					pcs. / package ks./bal.	€/ pcs. €/ ks	kg / pcs. kg/ks.
		A	B	C	D	E			
PPU46/40G	41446 01	46	40	94	200	16	20	5,69	0,630
PPU48/40G	41448 01	48	40	93	200	16	20	5,69	0,628
PPU50/40G-B	41450 00	50	40	92	200	16	20	5,69	0,630
PPU71/40G	41471 01	71	40	94	200	16	20	5,89	0,662
PPU73/40G	41473 01	73	40	93	200	16	20	5,89	0,662
PPU75/40G	41475 01	75	40	92	200	16	20	5,89	0,662
PPU70/60G	41070 01	70	60	97	200	16	20	5,28	0,848
PPU80/60G	41080 01	80	60	92	200	16	20	5,36	0,848
PPU90/60G	41090 01	90	60	97	200	16	20	5,48	0,891
PPU96/60G	41096 01	96	60	94	200	16	20	5,41	0,891
PPU98/60G	41098 01	98	60	93	200	16	20	5,46	0,891
PPU100/60G-B	41100 00	100	60	92	200	16	20	5,46	0,891
PPU120/60G-B	41120 00	120	60	102	200	16	20	6,79	1,021
PPU140/60G-B	41140 00	140	60	92	200	16	20	6,79	1,021
PDL75/60G-B	42205 00	75	60	94	450	16	15	12,83	1,222
PDL100/60G-B	42210 00	100	60	96	450	16	15	13,08	1,259

Prices quoted are exclusive of VAT / Ceny sú uvedené bez DPH

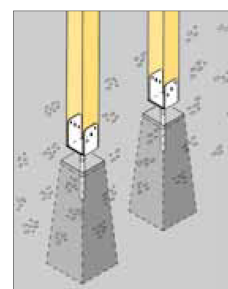
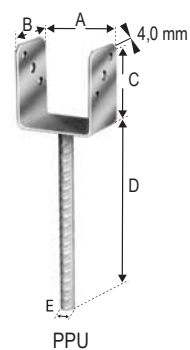

It. no. NEW č. p. NOVÉ	It. no. OLD č. p. STARÉ	Dimensions/ Rozmery [mm]					pcs. / package ks./bal.	€/ pcs. €/ ks	kg / pcs. kg/ks.
		A	B	C	D	E			
PTB48G	40700 01	48	60	106	39	100	10	20,78	1,020

Prices quoted are exclusive of VAT / Ceny sú uvedené bez DPH

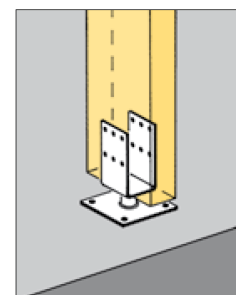
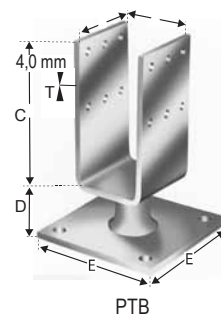

It. no. NEW č. p. NOVÉ	It. no. OLD č. p. STARÉ	Dimensions/ Rozmery [mm]				pcs. / package ks./bal.	€ / pcs. € / ks	kg / pcs. kg/ks.
		A	B	C	D			
PU70-B	40005 00	71	70	107	131	20	7,14	0,690
PU80-B	40030 00	81	70	102	126	20	7,14	0,690
PU90-B	40040 00	91	70	107	131	20	7,41	0,730
PU100-B	40050 00	101	70	102	126	20	7,41	0,730
PU120-B	40060 00	121	70	92	116	20	8,17	0,730
PU140-B	40070 00	141	70	82	106	20	8,17	0,730

Prices quoted are exclusive of VAT / Ceny sú uvedené bez DPH

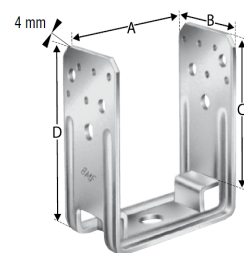

PU

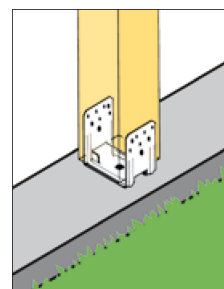

ETA 07/0285

It. no. NEW č. p. NOVÉ	It. no. OLD č. p. STARÉ	Dimensions/ Rozmery [mm]			pcs. / package ks./bal.	€ / pcs. € / ks	kg / pcs. kg/ks.
		A	B	C			
PUA45-B	29045 00	46	127	70	25	4,99	0,504
PUA50-B	29050 00	51	125	70	25	4,99	0,504
PUA60-B	29060 00	61	120	70	25	4,99	0,504
PUA70-B	29070 00	71	115	70	25	4,99	0,504
PUA80-B	29080 00	81	110	70	25	4,99	0,504
PUA90-B	29090 00	91	115	70	25	5,18	0,538
PUA100-B	29100 00	101	110	70	25	5,18	0,538
PUA120-B	29120 00	121	110	70	25	5,45	0,571
PUA/B42-B	29900 00	42	27	70	25	2,21	0,141
PUA/B47-B	29905 00	47	25	70	25	2,21	0,141
PUA/B57-B	29910 00	57	20	70	25	2,21	0,141
PUA/B67-B	29915 00	67	25	70	25	2,34	0,175
PUA/B77-B	29950 00	77	20	70	25	2,34	0,175
PUA/B87-B	29960 00	87	25	70	25	2,55	0,208
PUA/B97-B	29970 00	97	20	70	25	2,55	0,208
PUA/B117-B	29990 00	117	20	70	25	2,79	0,242

Prices quoted are exclusive of VAT / Ceny sú uvedené bez DPH

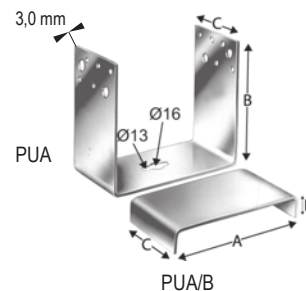

PUA

PUA/B

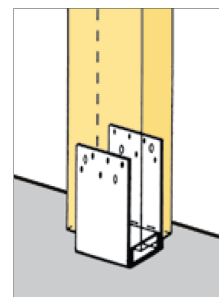



ETA 07/0285

It. no. NEW č. p. NOVÉ	It. no. OLD č. p. STARÉ	Dimensions/ Rozměry [mm]					pcs. / package ks./bal.	€/ pcs. €/ ks.	kg / pcs. kg/ks.
		A	B	C	D	E			
PVD80G-B	31950 00	80-120	120	70	248-298	160	10	49,74	2,052
PVD120G-B	31948 00	120-160	120	70	248-298	160	10	50,67	2,165
PVDB80G-B	31951 00	80-120	120	70	136-186	160	8	53,74	2,510
PVDB120G-B	31949 00	120-160	120	70	136-186	160	5	55,98	2,620
PVIG-B	31952 00	90	110	60	232-282	-	10	37,85	1,329
PVIBG-B	31953 00	90	110	60	120-170	-	10	42,33	1,787

Prices quoted are exclusive of VAT / Ceny sú uvedené bez DPH

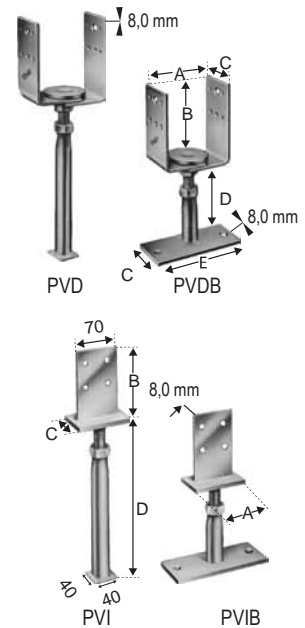

It. no. NEW č. p. NOVÉ	Dimensions/ Rozměry [mm]						pcs. / package ks./bal.	€/ pcs. €/ ks.	kg / pcs. kg/ks.
	A	B	C	D	E	F			
JDB18G	68	24	125	185-235	160	90	10	42,64	2,110
JGB18G	56	16	125	185-235	160	90	5	37,97	1,700
JGS30G	56	16	126	385-425	-	-	10	30,89	1,650
PDB17G	68	24	125	170	160	90	10	31,67	1,720
PDB27G	68	24	125	270	160	90	10	30,36	1,970
PDS50G	80	24	125	500	70	70	8	32,22	1,930

Prices quoted are exclusive of VAT / Ceny sú uvedené bez DPH

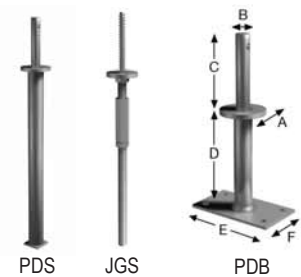
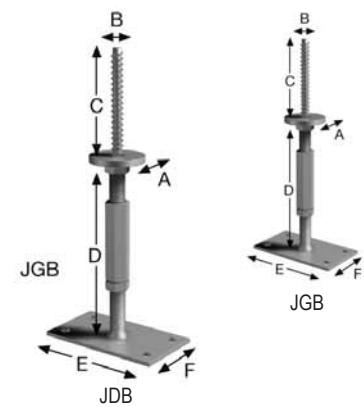

JDB



JGS



PDB



PDS



ETA 07/0314

It. no. NEW č. p. NOVÉ	It. no. OLD č. p. STARÉ	Dimensions/ Rozmery [mm]					pcs. / package ks./bal.	€ / pcs. € / ks	kg / pcs. kg/ks.
		A	A*	B	C	D			
HE175	16001 01	175	up to/do/pentru 315	40	30	15	100	1,60	0,184
HE135-B	16002 00	135		40	30	15	100	1,45	0,150
PROFA108-B	16100 00	108		35	22,5	8	100	1,08	0,078
PROFA158-B	16120 00	158		35	22,5	8	100	1,28	0,117
PROFA198-B	16140 00	198		35	22,5	8	100	1,58	0,148
PROFA159-B	16200 00	159	up to/do/pentru 359	35	30	9	100	1,42	0,160

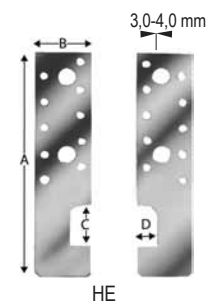

Build to order in 20 mm / Možnosť výroby na objednávku v 20 mm

Prices quoted are exclusive of VAT / Ceny sú uvedené bez DPH

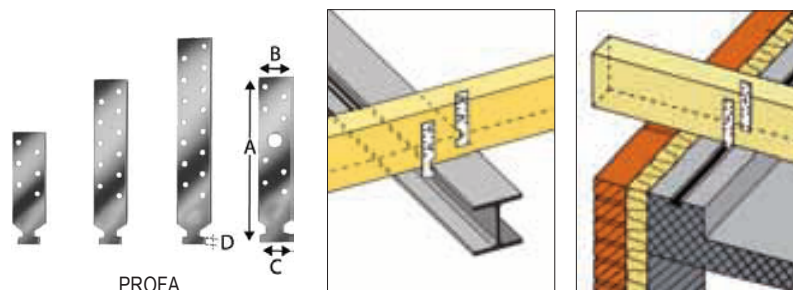

Connecting wallstrip/Pripojovací pás do steny

C2KS

It. no. č. p.	pcs. / package ks./bal.	€ / set. € / sada	kg / pcs. kg/ks.
Stainless steel / Ušľachtilá oceľ			
C2KS	10 set/sada	13,55	0,800

Prices quoted are exclusive of VAT / Ceny sú uvedené bez DPH

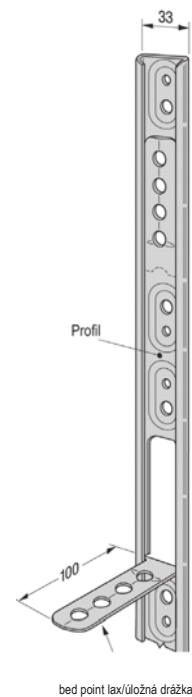
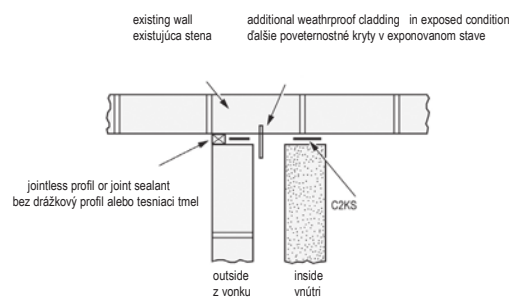
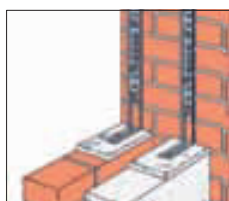

It. no. č. p.	Dimensions/ Rozmery [mm]			pcs. / package ks./bal.	€ / pcs. € / ks.	kg / pcs. kg/ks.
	A	B	C			
DBT1Z-R50	41	34	30	50	0,693	0,680
N3,75x30/1kg	Galvanized nail / Pozinkované klinec			10	20,22	1,000

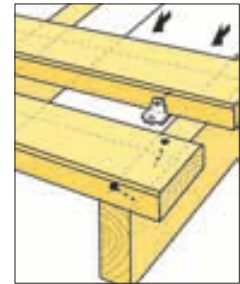
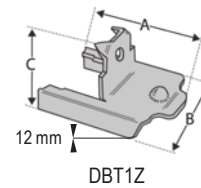

It. no. č. p.	Dimensions/ Rozmery [mm]			pcs. / package ks./bal.	€ / pcs. € / ks.	kg / pcs. kg/ks.
	A	B	C			
DBCS	30	39	11	100	0,78	0,022

Prices quoted are exclusive of VAT / Ceny sú uvedené bez DPH

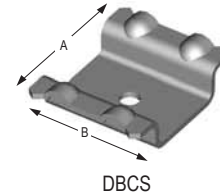

It. no. č. p.	pcs. / package ks./bal.	€ / pcs. € / ks.	kg / pcs. kg/ks.
HDMS-2	100	105,03	2,950
HDMS-7	100	105,03	3,150
HDMS-A60	20	19,37	0,650



Prices quoted are exclusive of VAT / Ceny sú uvedené bez DPH

It. no./č. p.	Content/Obsah
HDMS-2	80 St. Terrace connectors/Terasová spojka
	20 St. Connector for fitting of the edge/Spojka pre montáž hrany
	240 St. Screw for ground timber/ Skrutka pre drevenú podlahu 4,5x18 mm
	75 St. Screw for wooden beams/ Skrutka pre drevené nosníky 4,5x40 mm
	2 St. Bits Torx T20 L = 70 mm
HDMS-7	100 St. Terrace connectors/Terasová spojka
	240 St. Screw for ground timber/ Skrutka pre drevenú podlahu 4,5x18 mm
	120 St. Screw for wooden beams/ Skrutka pre drevené nosníky 4,5x40 mm
	2 St. Bits Torx T20 L = 70 mm
HDMS-A60	10 St. Angle bracket/Uholník
	50 St. Screw for ground timber/skrutka pre drevenú podlahu 4,5x18 mm
	25 St. Screw for wooden beams/skrutka pre drevené nosníky 4,5x40 mm

Terrace clips from Simpson Strong-Tie are price friendly solution for montage of terrace and balcony floor. Terrace connector EB-TY is made from plastic which is very resistant against outdoor conditions. It comes together with screws which are made from stainless steel.

Terasové spoje Simpson Strong-Tie sú cenovo výhodným riešením pre montáž terasových a balkónových podláh. Terasové spojky EB-TY sa skladajú z plastového dielu, ktorý je odolný vonkajším podmienkam a je dodávaný spoločne s príslušnými skrutkami z ušľachtilej ocele.

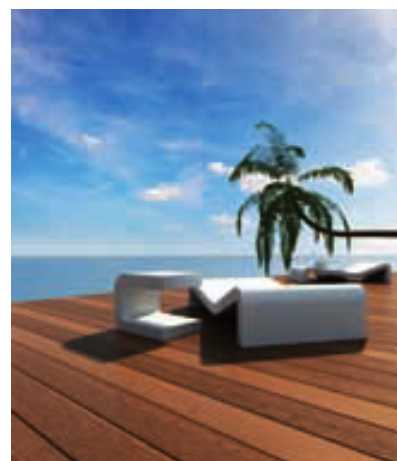

175-EBTYW

Applications:

13 mm and 25 mm wide timber
Suitable for pine wood and cedar

Dimension:

High: 13mm; Wide: 25 mm
Long: 59 mm; Strong: 4 mm
Path-strong: 2,5 mm

Požítie:

13 mm a 25 mm široké drevo.
Vhodné pre borové a cédrové drevo

Rozmery:

Výška: 13mm; Šírka: 25 mm
Dĺžka: 59 mm; Hrúbka: 4 mm
Hrúbka mostíka: 2,5 mm



175-EBTYLC

Applications:

Suitable for artificially dried wood, jointed wood and natural wood

Dimension:

High: 13mm; Wide: 25 mm
Long: 60 mm; Strong: 4 mm
Path-strong: 6 mm

Požítie:

Vhodné pre umelo vysušené drevo, lepené drevo a surové prírodné drevo

Rozmery:

Výška: 13mm; Šírka: 25 mm
Dĺžka: 60 mm; Hrúbka: 4 mm
Hrúbka mostíka: 6 mm



175-EBTYBG

Applications:

Suitable for stronger plant flooring, which are most often placed on sands malls

Dimension:

High: 16 mm; Wide: 33 mm
Long: 66 mm; Strong: 4 mm
Path-strong: 6 mm

Požítie:

Vhodné pre hrubšie terasové dosky, ktoré sú často umiestnené na chodníkoch

Rozmery:

Výška: 16 mm; Šírka: 33 mm
Dĺžka: 66 mm; Hrúbka: 4 mm
Hrúbka mostíka: 6 mm



Material/Materiál:

plastic, black / plast čierny

Type of joint/Typ spoja:

floor joint / podlahový

Attachment/Upevnenie:

by screwing SK screws from stainless steel 4,5 mm x 55 mm/ zoskrutkované pomocou SK skrutiek z ušľachtilej ocele priemeru 4,5mm x 55 mm

Benefits/Prednosti:

accurate and fast assembly/presná a rýchla montáž

Use for/Použitie:

main use for terrace and balcony floors, shutters etc. /pre terasové a balkónové podlahy a ďalšie

lt. no. NEW č. p. NOVÉ	lt. no. OLD č. p. STARÉ	pcs. / package ks./bal.	€ / pcs. € / ks	kg / pcs. kg/ks.
ABR9020S-B	ABR9020S	*		*
ABR9015S-B	ABR9015S	*		*
ABR90S-B	07090 80	50	8,17	0,200
AB90S-B	07091 80	100	8,72	0,200
ABR105S-B	07105 80	50	14,93	0,382
AB105S-B	07106 80	50	16,36	0,382
ABR70S-B	07070 80	100	5,36	0,108
AB70S-B	07071 80	100	5,89	0,108
AC35350S	AC35350S	100	3,80	0,048
ABB40390S-B	07390 80	100	6,94	0,161
AC55365S-B	07365 80	100	6,37	0,150
ANP256660S-B	08666 80	100	7,16	0,136
BSN260S-X _(60x100)	03112 80	1	11,75	0,270
BSN320S-X _(80x120)	03221 80	50	14,61	0,380
BSN380S-X _(100x140)	03318 80	1	18,43	0,433
BSN440S-X _(120x160)	03421 80	1	22,10	0,580
BSN500S-X _(140x180)	03521 80	1	24,65	0,650
SPF170LS-B	02170 80	100	5,71	0,096
SPF170RS-B	02171 80	100	5,71	0,096
SPF210LS-B	02210 80	100	7,51	0,134
SPF210RS-B	02211 80	100	7,51	0,134
BAN204025S	27419 80	1	574,90	15,000
BAN102010S	27110 80	10	62,52	1,525

Price and delivery time on request /Cena a doba dodania na vyžiadanie
Prices quoted are exclusive of VAT / Ceny sú uvedené bez DPH

lt. no. NEW č. p. NOVÉ	lt. no. OLD č. p. STARÉ	pcs. / package ks./bal.	€ / package € / bal.	kg / package kg/bal.
CNA4,0X40S	99440 80	250	79,65	1,073
CNA4,0X50S	99450 80	250	101,13	1,400
CNA4,0X60S	99460 80	250	105,95	1,708
CNA6,0X60S	99660 80	100	106,40	1,525
CSA5,0X25S	95525 80	250	70,98	0,628
CSA5,0X35S	95535 80	250	77,19	0,935
CSA5,0X40S	95540 80	250	79,95	0,975

Prices quoted are exclusive of VAT / Ceny sú uvedené bez DPH



ABR9020S-B

ABR9015S-B

ABR90S-B



AB90S-B



ABR105S-B



AB105S-B



ABR70S-B

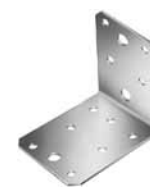

AB70S-B



AC35350S



ABB40390S-B



AC55365S-B



ANP256660S-B



BSN



SPF L



SPF R



BAN204025S



BAN102010S



CNA



CSA



ETA 07/0314

lt. no. NEW č. p. NOVÉ	lt. no. OLD č. p. STARÉ	Dimensions/ Rozmery [mm]			pcs. / package ks./bal.	€ / pcs. € / ks	kg / pcs. kg/ks.
		A	B	C			
BETA2/200-B	17200 00	40	180	20	150	1,12	0,118
BETA2/300-B	17300 00	40	280	20	100	1,54	0,176
BETA2/400-B	17400 00	40	380	20	80	2,34	0,230
BETA2/500-B	17500 00	40	480	20	50	3,37	0,296
BETA2/600-B	17600 00	40	580	20	50	3,97	0,350
BETA4/200-B	17204 00	40	180	20	75	2,48	0,251
BETA4/300-B	17304 00	40	280	20	50	3,80	0,376
BETA4/400-B	17404 00	40	380	20	40	4,53	0,500
BETA4/500-B	17504 00	40	480	20	25	6,02	0,632
BETA4/600-B	17604 00	40	580	20	25	6,79	0,760

Prices quoted are exclusive of VAT / Ceny sú uvedené bez DPH

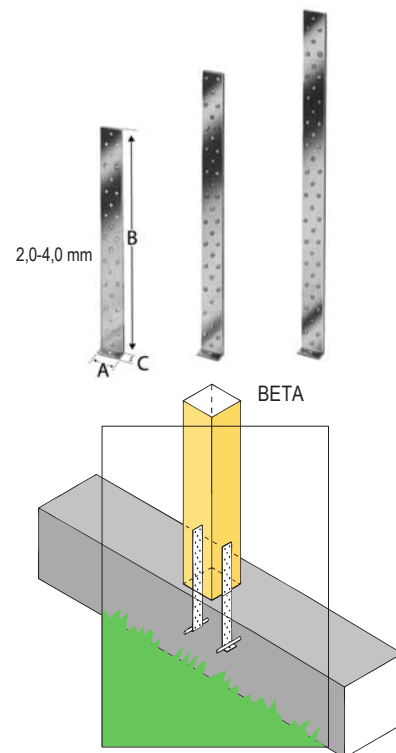

Tension Tie/Ťahová kotva

HD



ETA 07/0314

lt. no. NEW č. p. NOVÉ	lt. no. OLD č. p. STARÉ	Dimensions/ Rozmery [mm]				pcs. / package ks./bal.	€ / pcs. € / ks	kg / pcs. kg/ks.
		A	B	C	D			
HD340M12G-B	10405 00	340	182	40	15	10	19,73	1,279
HD400M16G-B	10410 00	400	123	40	15	10	22,24	1,228
HD420M16G-B	10415 00	420	222	60	20	8	31,19	2,435
HD420M20G-B	10420 00	420	102	60	20	10	22,24	1,221
HD480M20G-B	10425 00	480	123	60	20	10	28,56	1,844

Prices quoted are exclusive of VAT / Ceny sú uvedené bez DPH

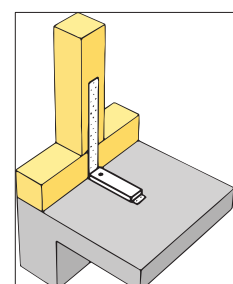
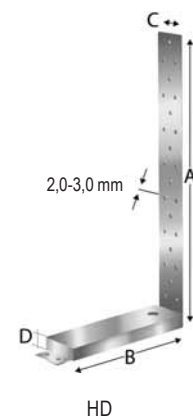



ETA 07/0314

It. no. č. p.	Dimensions/ Rozmery [mm]			pcs. / package ks./bal.	€ / pcs. € / ks	kg / pcs. kg/ks.
	A	B	C			
LTT20B	502	70	51	10	13,35	0,750
HTT5 (replace/nahrádza HTT16)	406	61	64	10	23,44	0,951
HTT22	559	61	70	10	26,69	1,200

Prices quoted are exclusive of VAT / Ceny sú uvedené bez DPH

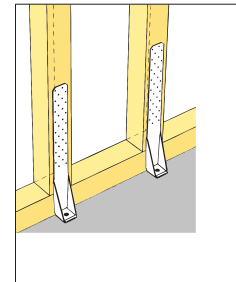
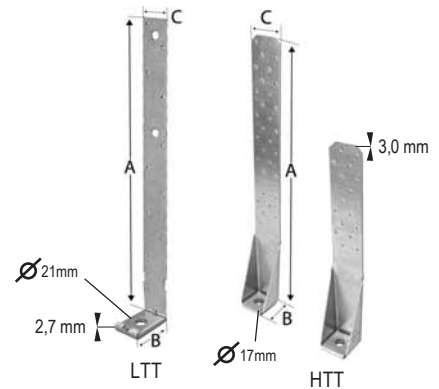

ETA 07/0314

It. no. NEW č. p. NOVÉ	It. no. OLD č. p. STARÉ	Dimensions/ Rozmery [mm]			pcs. / package ks./bal.	€ / pcs. € / ks	kg / pcs. kg/ks.
		A	B	C			
HD2P60G-B	10430 00	400	220	60	10	22,24	1,500
HD2P40G	HD2P40G	250	163	40	10	25,32	0,850
HD2PL40G	HD2PL40G	250	379	40	5	36,26	1,800
HD2PSG	HD2PSG	336	163	60	10	38,43	1,500
HD2PLSG	HD2PLSG	336	379	60	5	49,72	2,500
HD2P1L-B		380	220	55			
HD2P1R-B		380	220	55			
HD2P2L-B		380	163	55			
HD2P2R-B		380	163	55			
US40/50/10G-B	07002 00	40	50	-	50	2,59	0,157
US50/50/8G-B	07003 00	50	50	-	50	2,59	0,157
JT2-3-5,5x25 100 pcs./ks	95022 00	E-JOT screw/skrutka JT2- 3/5,5x25			100	32,69	0,618

Price and delivery time on request /Cena a doba dodania na vyžiadanie
Prices quoted are exclusive of VAT / Ceny sú uvedené bez DPH

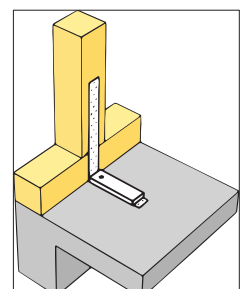
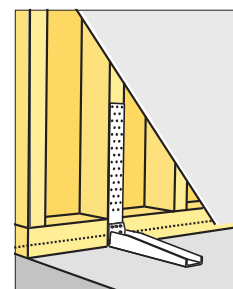
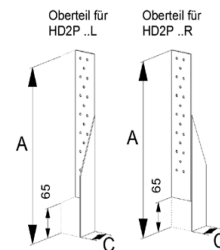
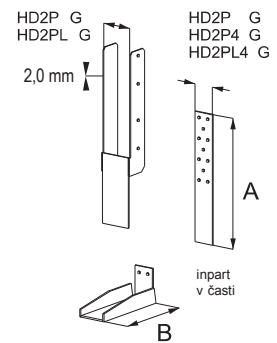
Upper part for/
Horná časť preUpper part for/
Horná časť pre



ETA 07/0314

It. no. NEW č. p. NOVÉ	It. no. OLD č. p. STARÉ	Dimensions/ Rozmery [mm]				pcs. / package ks./bal.	€ / pcs. €/ ks	kg / pcs. kg/ks.
		A	B	C	T			
AH9035	07035 01	90	35	40	2,5	100	0,91	0,100
AH16050	07050 01	160	50	40	3,0	100	1,91	0,184
AH19050/2	07051 01	192	52	40	2,0	100	1,49	0,151
AH29050/2	07052 01	292	52	40	2,0	50	2,00	0,212
AH39050/2	AH39050/2	390	52	40	2,0	25	1,90	0,280
AH49050/2	AH49050/2	492	52	40	2,0	25	2,30	0,340
AH61050/2	AH61050/2	612	52	40	2,0	25	2,86	0,420
AH19050/4	AH19050/4	194	54	40	4,0	50	2,27	0,300
AH29050/4	AH29050/4	294	54	40	4,0	25	3,25	0,420
AH39050/4	AH39050/4	394	54	40	4,0	25	4,20	0,550
AH49050/4	AH49050/4	494	54	40	4,0	25	5,13	0,680
AH61050/4	AH61050/4	614	54	40	4,0	25	6,36	0,830
US40/50/10G-B	07002 00	40	50	-	10,0	50	2,59	0,157

Prices quoted are exclusive of VAT / Ceny sú uvedené bez DPH

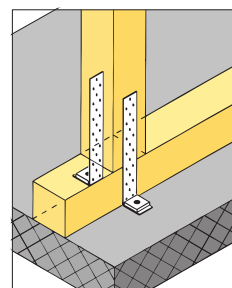
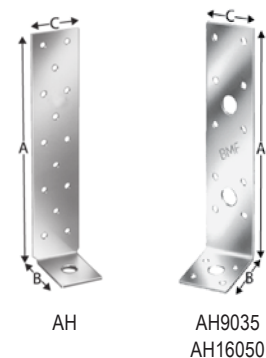

It. no. NEW č. p. NOVÉ	It. no. OLD č. p. STARÉ	Dimensions/ Rozměry [mm]				pcs. / package ks./bal.	€ / pcs. € / ks	kg / pcs. kg/ks.
		A	B	C	T			
RFC80/120	RFC80/120	185	70	32	2,0	30	3,08	0,240
EBR60-B	07995 00	80	80	57	1,5	100	1,44	0,105
EBR80-B	07996 00	123	123	74	1,5	100	2,07	0,206
TA9Z	TA9Z	210	41	–	2,5	50	3,40	0,290
TA10Z	TA10Z	260	41	–	2,5	50	4,07	0,340
FLVW40/100	FLVW40/100	53	53	40	2,5	100	0,78	0,080
FLVW40/180	FLVW40/180	93	93	40	3,0	100	1,09	0,173
FLVW40/100-135	FLVW40/100-135	50	50	40	2,5	100	0,94	0,080
FLVW40/180-135	FLVW40/180-135	90	90	40	3,0	100	1,21	0,173
FLVW55/135-135	FLVW55/135-135	70	70	55	2,0	100	0,95	0,119
66L	66L	38	150	150	2,0	25	1,42	0,180
66T	66T	38	125	150	2,0	25	1,77	0,180

Prices quoted are exclusive of VAT / Ceny sú uvedené bez DPH

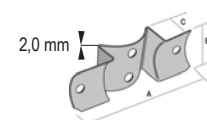

RFC

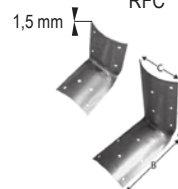

EBR

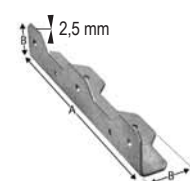

TAZ

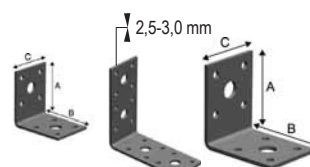

FLVW

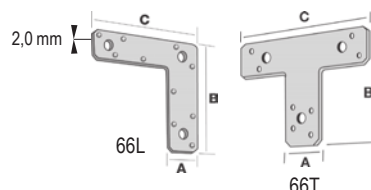

66L

66T

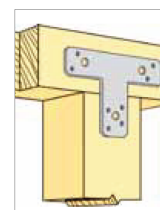
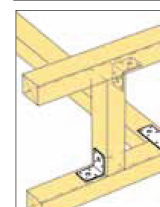
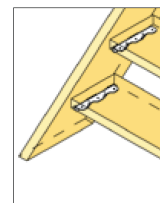
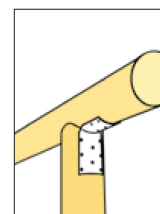

It. no. NEW č. p. NOVÉ	It. no. OLD č. p. STARÉ	Dimensions/ Rozměry [mm]				pcs. / package ks./bal.	€ / pcs. € / ks	kg / pcs. kg/ks.
		A	B	C	T			
CRE50	CRE50	18	50	50	4,0	150	0,79	0,050
CRE70	CRE70	18	70	70	4,0	150	0,86	0,070
CRE100	CRE100	18	100	100	4,0	100	1,03	0,110
CRE120	CRE120	18	120	120	4,0	50	1,54	0,130
CRE140	CRE140	18	140	140	4,0	50	1,42	0,150
CRE160	CRE160	20	160	160	4,0	50	2,02	0,200
CRE190	CRE190	20	190	190	4,0	50	2,50	0,230
CRE250	CRE250	20	250	250	4,0	50	3,96	0,310
EC30/2	EC30/2	15	30	30	2,0	500	0,34	0,013
EC40/2	EC40/2	15	40	40	2,0	500	0,40	0,017
EC50/2	EC50/2	15	50	50	2,0	500	0,43	0,021
EC60/2	EC60/2	15	60	60	2,0	500	0,29	0,027
EC70/2,5	EC70/2,5	15	70	70	2,5	200	0,36	0,039
EC80/2,5	EC80/2,5	15	80	80	2,5	200	0,42	0,045
EC90/3	EC90/3	18	90	90	3,0	200	1,46	0,073
EC100/3	EC100/3	18	100	100	3,0	200	1,58	0,075
EC120/3	EC120/3	18	120	120	3,0	200	0,73	0,098
EC140/3	EC140/3	18	140	140	3,0	200	1,18	0,115
EFIXR553	EFIXR553	50	55	30	2,0	150	0,40	0,040

Prices quoted are exclusive of VAT / Ceny sú uvedené bez DPH

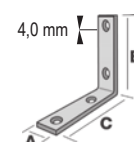

CRE

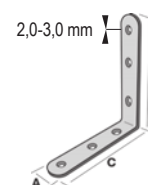

EC

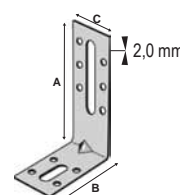

EFIXR553

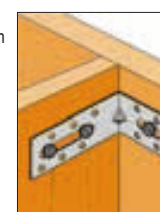

It. no. NEW č. p. NOVÉ	It. no. OLD č. p. STARÉ	Dimensions/ Rozmery [mm]					pcs. / package ks./bal.	€ / pcs. € / ks.	kg / pcs. kg/ks.
		A	B	C	D	T			
PT30G	PT30G	80	24	–	300	–	1		1,900
PCR24/50G	PCR24/50G	80	24	123	531	–	1		1,700
PBR24/50G	PBR24/50G	80	24	123	495	–	1		2,100
PPH90	49009 01	90	60	600	–	6,0	1	23,73	3,900
PPH100	49010 01	100	60	600	–	6,0	1	25,04	3,960
PPH120	49012 01	120	60	600	–	6,0	1	26,35	4,075
PPHB70	49107 01	70	50	206	200	5,0;6,0	1	9,88	1,360
PPHB90	49109 01	90	50	206	200	5,0;6,0	1	9,88	1,360
PPHB100	49110 01	100	50	206	200	5,0;6,0	1	9,88	1,360
PPHB120	49112 01	120	50	206	200	5,0;6,0	1	9,88	1,360
PPJET50/50/750	49305 01	50	50	150	750	2,0	1	13,04	1,120
PPJET50/75/750G	49307 01	50	75	150	750	2,0	1	13,08	1,740
PPJET50/100/750	49310 01	50	100	150	750	2,0	1	15,79	2,040
PPJET75/75/750	49320 01	75	75	150	750	2,0	1	14,84	2,010
PPJET100/100/750	49330 01	100	100	150	750	2,0	1	17,36	2,640
PPJET70/70/750	49375 01	70	70	150	750	2,0	1	13,17	1,880
PPJET90/90/900G	49390 01	90	90	150	900	2,0	1	16,64	2,740
PPJET90/90/750G	49391 01	90	90	150	750	2,0	1	14,86	2,390
PPJRE38/380	49038 01	Ø 38	–	150	377	2,0	15	17,64	1,000
CP	CP	30	38	35	–	2,0	150	2,42	0,049



Price and delivery time on request /Cena a doba dodania na vyžiadanie
Prices quoted are exclusive of VAT / Ceny sú uvedené bez DPH

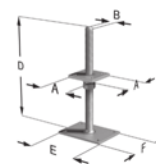

PT30G



PCR24/50G



PBR24/50



PPH

PPHB

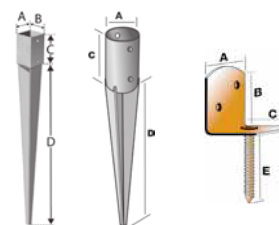

PPJET

PPJRE

CP

It. no. NEW č. p. NOVÉ	It. no. OLD č. p. STARÉ	Dimensions/ Rozměry [mm]				pcs. / package ks./bal.	€ / pcs. € / ks	kg / pcs. kg/ks.
		A	B	C	T			
SRC	SRC	Ø 61	55	82	44	20	5,85	0,180
SRR	SRR	Ø 61	55	80/100	44	20	7,79	0,210
SRD	SRD	Ø 61	55	53	–	20	3,52	0,150
CF-R	CF-R	29	154	127	1,6	25	3,48	0,160
SBV	SBV	20	232	279	1,6	24	4,33	0,400
FLV40/100	FLV40/100	40	100	–	2,5	100	0,68	0,080
FLV40/180	FLV40/180	40	180	–	3,0	100	1,00	0,173
FLV55/135	FLV55/135	55	135	–	2,0	100	0,84	0,119

Prices quoted are exclusive of VAT / Ceny sú uvedené bez DPH

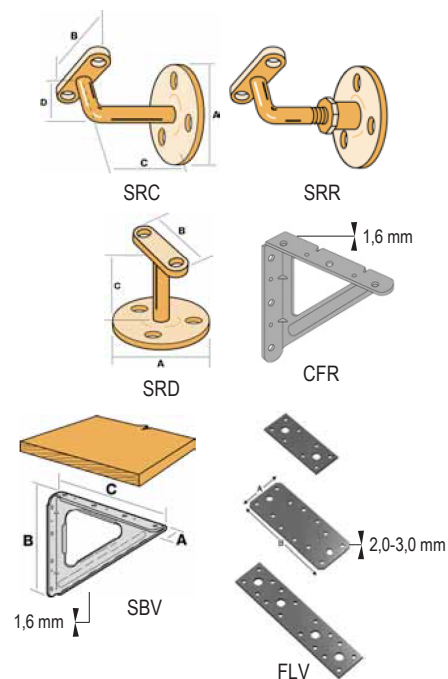

Fasteners/Spojovací materiál

SPAX®-SCREW / skrutka

It. no./č. pol./Nu. art.		Dimensions/ Rozměry [mm]	pcs. / package ks./bal.	€ / package € / bal.	kg / package kg/bal.
95560 00	SPAX	6,0 x 60	200	46,46	1,600
95570 00	SPAX	5,0 x 70	200	40,66	1,270
95580 00	SPAX	5,0 x 80	200	46,66	1,450

Prices quoted are exclusive of VAT / Ceny sú uvedené bez DPH



ETA 04/0013

It. no. NEW č. p. NOVÉ	It. no. OLD č. p. STARÉ	Dimensions/ Rozmery [mm]		pallet / package pal./bal.	pcs. / package ks./bal.	€ / package € / bal.	kg / package kg/bal.
		Ø	L				
CNA2,5x35	99253 00	2,5	35	480	500	10,66	0,867
CNA2,8x60	99286 00	2,8	60	480	250	8,28	0,825
CNA3,1x22	99312 00	3,1	22	480	500	11,17	0,842
CNA3,1x40	99314 00		40	480	500	13,93	1,348
CNA3,1x60	99316 00		60	480	250	9,57	0,966
CNA3,4x60	99346 00	3,4	60	480	250	10,81	1,183
CNA3,7x50	99375 00	3,7	50	480	250	15,36	1,180
CNA4,0x35	99435 00	4,0	35	480	250	8,27	1,033
CNA4,0x40	99440 00		40	480	250	4,98	1,133
CNA4,0x40G ²⁾	99440 60		40	480	250	12,11	1,250
CNA4,0x40S ³⁾	99440 80		–	250	–	79,65	1,133
CNA4,0x50	99450 00		50	480	250	10,02	1,400
CNA4,0x50S ³⁾	99450 80		–	250	–	101,13	1,400
CNA4,0x60	99460 00		60	480	250	11,04	1,708
CNA4,0x60S ³⁾	99460 80		–	250	–	105,95	1,708
CNA4,0x75	99475 00		75	480	250	9,04	2,083
CNA4,0x100	99410 00		100	320	250	19,72	2,693
CNA6,0x60	99660 20		6,0	60	80	100	
CNA6,0x60S ³⁾	99660 80	–		100	–	106,40	1,525
CNA6,0x80	99680 20	80		192	100		1,840
CNA6,0x100	99610 20	100		256	100		2,390

2) Galvanized/Pozinkované ~50µm

3) Stainless steel / Ušľachtilá oceľ 1.4401



Price and delivery time on request /Cena a doba dodania na vyžiadanie

Prices quoted are exclusive of VAT / Ceny sú uvedené bez DPH

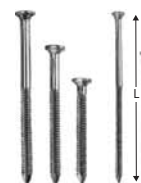

CNA



ETA 04/0013

It. no. NEW č. pol. NOVÉ	It. no. OLD č. pol. STARÉ	Dimensions/ Rozmery [mm]		€ / package € / bal.	pcs. / package ks./bal.	kg / package kg/bal.	
		Ø	L				
CSA4,0x30	95430 00	4,0	30	15,86	250	0,755	
CSA5,0x25	95525 00	5,0	25	18,95	250	0,628	
CSA5,0x25S ³⁾	95525 80			70,98	250	0,628	
CSA5,0x35	95535 00		35	18,36	250	0,935	
CSA5,0x35S ³⁾	95535 80			77,19	250	0,935	
CSA5,0x40	95540 00		40	22,35	250	0,975	
CSA5,0x40S ³⁾	95540 80			79,95	250	0,975	
	95550 00 ²⁾		50	50	27,50	250	1,150
CSA5,0x50DE ¹⁾							

1) Not suitable for ATF / Nevhodné pre ATF

2) For ATF / Vhodné pre ATF

3) Stainless steel / Ušľachtilá oceľ 1.4401

Prices quoted are exclusive of VAT / Ceny sú uvedené bez DPH

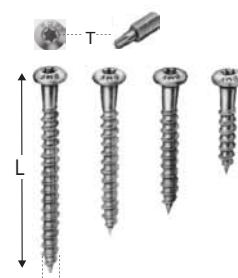

CSA

SN-BATTEN NAILS / Krovové klinec

It. no. NEW č. pol. NOVÉ	It. no. OLD č. pol. STARÉ	Dimensions/ Rozmery/ [mm]		pcs. / package ks./bal.	€/ pcs. €/ ks	kg / package kg/bal. kg./pac.
		Ø	L			
SN6,0x80	96680 20	6,0	80	125	0,15	2,450
SN6,0x110	96611 20		110	125	0,21	3,350
SN6,0x150	96615 20		150	125	0,24	4,530
SN6,0x180	96618 20		180	125	0,39	5,550
SN6,0x210	96621 20		210	125	0,45	6,450
SN6,0x230	96623 20		230	125	0,54	7,130
SN6,0x260	96626 20		260	125	0,62	8,020
SN6,0x280	96628 20		280	125	0,68	8,610
SN6,0x300	96630 20		300	125	0,74	9,210
SN6,0x330	96633 20		330	125	0,88	10,450
SN6,0x360	96636 20		360	125	1,17	10,570

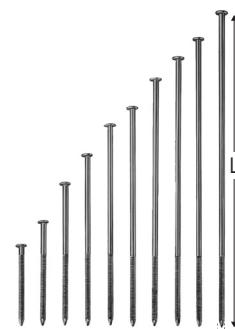

SN

Prices quoted are exclusive of VAT / Ceny sú uvedené bez DPH

CONCRETE SCREW / Skrutka do betónu

It. no. NEW č. pol. NOVÉ	It. no. OLD č. pol. STARÉ	pcs. / package ks./bal.	€/ pcs. €/ ks	kg / package kg/bal.
SBS5X42	95654 00	250		1,183



Price and delivery time on request /Cena a doba dodania na vyžiadanie

Prices quoted are exclusive of VAT / Ceny sú uvedené bez DPH

STD STEEL DOWELS / KOLÍKY

It. no. NEW č. pol. NOVÉ	It. no. OLD č. pol. STARÉ	Dimensions/ Rozmery [mm]		pcs. / package ks./bal.	€/ pcs. €/ ks	kg / pcs. kg/ks.
		Ø	L			
STD6x66-B	33040 00	6	66	100	0,43	0,014
STD8x45-B	33045 00	8	45	100	0,47	0,017
STD8x60-B	33060 00	8	60	100	0,53	0,024
STD8x65-B	33065 00	8	65	100	0,54	0,026
STD8x70-B	33070 00	8	70	100	0,56	0,027
STD8x80-B	33080 00	8	80	100	0,58	0,034
STD8x90-B	33090 00	8	90	100	0,61	0,036
STD8x100-B	33100 00	8	100	100	0,65	0,042
STD8x115-B	33115 00	8	115	100	0,68	0,046
STD8x120-B	33120 00	8	120	100	0,68	0,050
STD8x140-B	33140 00	8	140	100	0,79	0,056
STD8x160-B	33142 00	8	160	100	0,90	0,059
STD10x90-B	33150 00	10	90	100	0,87	0,056
STD10x100-B	33151 00	10	100	100	1,03	0,060
STD10x120-B	33152 00	10	120	100	1,08	0,073
STD10x140-B	33153 00	10	140	100	1,24	0,086
STD12x60-B	33195 00	12	60	100	1,01	0,054
STD12x65-B	33200 00	12	65	100	0,98	0,056
STD12x80-B	33202 00	12	80	100	1,17	0,074
STD12x90-B	33205 00	12	90	100	1,24	0,078
STD12x100-B	33207 00	12	100	100	1,25	0,091
STD12x110-B	33208 00	12	110	100	1,35	0,101
STD12x115-B	33210 00	12	115	100	1,40	0,100
STD12x120-B	33212 00	12	120	100	1,43	0,109
STD12x130-B	33213 00	12	130	100	1,51	0,111
STD12x140-B	33215 00	12	140	100	1,57	0,122
STD12x160-B	33220 00	12	160	100	1,65	0,145
STD12x180-B	33230 00	12	180	100	1,85	0,153
STD12x200-B	33235 00	12	200	100	2,13	0,160



STD

It. no. NEW č. pol. NOVÉ	It. no. OLD č. pol. STARÉ	Dimensions/ Rozmery [mm]		pcs. / package ks./bal.	€/ pcs. €/ ks	kg / pcs. kg/ks.
		Ø	L			
STD16x120-B	33310 00	16	120	50	2,06	0,217
STD16x140-B	33315 00	16	140	50	2,42	0,232
STD16x150-B	33320 00	16	150	50	2,56	0,240
STD16x160-B	33325 00	16	160	50	2,73	0,299
STD16x180-B	33328 00	16	180	50	3,09	0,309
STD16x200-B	33330 00	16	200	50	3,43	0,319
STD16x250-B	33340 00	16	250	50	4,28	0,398
STD20x200-B	33430 00	20	200	25	5,28	0,497
STD20x250-B	33440 00	20	250	25	6,34	0,621
STD8x45G-B	33045 60	8	45	100	0,56	0,017
STD8x65G-B	33065 60	8	65	100	0,67	0,026
STD8x80G-B	33080 60	8	80	100	0,69	0,034
STD8x90G-B	33090 60	8	90	100	0,73	0,036
STD8x100G-B	33100 60	8	100	100	0,77	0,042
STD8x115G-B	33115 60	8	115	100	0,79	0,046
STD8x120G-B	33120 60	8	120	100	0,80	0,050
STD8x140G-B	33140 60	8	140	100	0,98	0,056
STD12x65G-B	33200 60	12	65	100	1,16	0,056
STD12x80G-B	33202 60	12	80	100	1,42	0,074
STD12x90G-B	33205 60	12	90	100	1,47	0,078
STD12x100G-B	33207 60	12	100	100	1,51	0,091
STD12x115G-B	33210 60	12	115	100	1,67	0,100
STD12x120G-B	33212 60	12	120	100	1,73	0,109
STD12x140G-B	33215 60	12	140	100	1,88	0,122

B Galvanized / Galvanicky pozinkované

G-B Zinc dipping / Žiarovo pozinkované

Prices quoted are exclusive of VAT / Ceny sú uvedené bez DPH

It. no. NEW č. pol. NOVÉ	It. no. OLD č. pol. STARÉ	Dimensions/ Rozměry [mm]				pcs. / package ks./bal.	€/ pcs. €/ ks	kg / pcs. kg/ks.
		d ₁	d _c	h _c	h ₁			
C2-50M10G-B	80005 00	M10	50	6,6	-	300	0,59	0,017
C2-50M12G-B	80010 00	M12				300	0,59	0,019
C2-50M16G-B	80020 00	M16				300	0,59	0,018
C2-50M20G-B	80025 00	M20	62	8,7	-	300	0,59	0,016
C2-62M12G-B	80030 00	M12				150	0,97	0,035
C2-62M16G-B	80040 00	M16				150	0,97	0,034
C2-62M20G-B	80050 00	M20	75	10,4	-	150	0,97	0,034
C2-75M12G-B	80055 00	M12				100	1,25	0,048
C2-75M16G-B	80060 00	M16				100	1,25	0,050
C2-75M20G-B	80070 00	M20				100	1,25	0,050
C2-75M22G-B	80071 00	M22	75	10,4	-	100	1,25	0,048
C2-75M24G-B	80072 00	M24				100	1,25	0,048
C2-95M16G-B	80080 00	M16				95	12,7	-
C2-95M20G-B	80081 00	M20	50	2,30	0,083			
C2-95M22G-B	80082 00	M22	50	2,30	0,083			
C2-95M24G-B	80083 00	M24	50	2,30	0,083			
C2-117M16G-B	80090 00	M16	117	16,0	-	40	3,77	0,145
C2-117M20G-B	80100 00	M20				40	3,77	0,145
C2-117M22G-B	80105 00	M22				40	3,77	0,142
C2-117M24G-B	80110 00	M24				40	3,77	0,142
C2-117M26G-B	80115 00	M26	73x130	14,8	-	40	3,77	0,142
C4-70/130M16G-B	80130 00	M16				50	3,32	
C4-73/130M20G-B	80135 00	M20				50	3,32	0,113
C4-73/130M24G-B	80145 00	M24	50	3,32	0,110			

Prices quoted are exclusive of VAT / Ceny sú uvedené bez DPH



C2

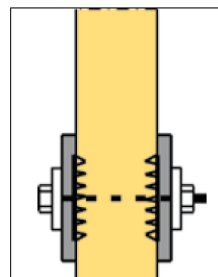

It. no. NEW č. pol. NOVÉ	It. no. OLD č. pol. STARÉ	Dimensions/ Rozměry [mm]				pcs. / package ks./bal.	€/ pcs. €/ ks	kg / pcs. kg/ks.
		d ₁	d _c	h _c	h ₁			
C1-50-B	80200 00	17	50	13,0	6,0	200	0,57	0,015
C1-62-B	80201 00	21	62	16,0	7,4	100	0,91	0,030
C1-75-B	80202 00	26	75	19,5	9,1	100	1,10	0,050
C1-50G-B	80210 00	17	50	13,0	6,0	200	0,62	0,022
C1-62G-B	80220 00	21	62	16,0	7,4	100	0,97	0,039
C1-75G-B	80230 00	26	75	19,5	9,1	100	1,28	0,054
C1-95G-B	80240 00	33	95	24,0	11,3	40	2,35	0,094
C1-117G-B	80250 00	48	117	30,0	14,3	25	3,89	0,157
C5-100G-B	80260 00	40	100	16,0	7,3	50	2,82	0,114
C5-130G-B	80270 00	52	130	20,0	9,3	25	6,34	0,205
C3-73/130G-B	80280 00	26	70x130	28,0	13,3	50	3,23	0,113
C1-140G-B	80290 00	60	140	31,0	14,7	25	11,48	0,220
C1-165G-B	80295 00	70	165	33,0	15,6	25	13,60	0,360

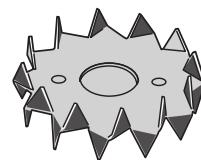

C1

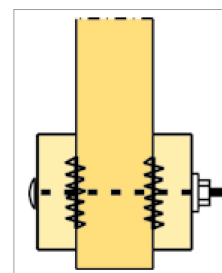

B Galvanized / Galvanicky pozinkované

G-B Zinc dipping / Žiarovo pozinkované

Prices quoted are exclusive of VAT / Ceny sú uvedené bez DPH

It. no. NEW č. pol. NOVÉ	It. no. OLD č. pol. STARÉ	Dimensions/ Rozměry [mm]				pcs. / package ks./bal.	€ / pcs. € / ks	kg / pcs. kg/ks.
		d ₁	d _c	h _c	d ₃			
A1-65-B	80460 00	-	65	30	-	150	3,11	0,060
A1-80-B	80461 00		80	30		100	3,53	0,080
A1-95-B	80462 00		95	30		100	3,80	0,095
A1-126-B	80463 00		126	30		50	5,51	0,126
A1-128-B	80464 00		128	45		25	8,36	0,280
A1-160-B	80465 00		160	45		25	12,56	0,340
A1-190-B	80466 00		190	45		20	16,74	0,500
B1-65M12-B	80450 00	M12	65	23	22,5	200	3,80	0,050
B1-80M12-B	80451 00	M12	80	23	35,5	100	5,51	0,090
B1-95M12-B	80452 00	M12	95	23	33,5	100	6,56	0,130
B1-128M12-B	80453 00	M12	128	32,5	45	50	11,48	0,300
B1-160M16-B	80454 00	M16	160	34,5	50	20	14,37	0,500
B1-190M16-B	80455 00	M16	190	34,5	60	20	19,35	0,750

Prices quoted are exclusive of VAT / Ceny sú uvedené bez DPH



B1



A1

It. no. NEW č. pol. NOVÉ	It. no. OLD č. pol. STARÉ	Dimensions/ Rozměry [mm]			pcs. / package ks./bal.	€ / pcs. € / ks	kg / pcs. kg/ks.
		d ₁	d _c	h _c			
C10-50-B	80412 00	30,5	50	27	400	0,91	0,050
C10-65-B	80414 00	35,5	65	27	150	1,55	0,093
C10-80-B	80416 00	49,5	80	27	150	2,20	0,113
C10-95-B	80418 00	65,5	95	27	100	2,89	0,140
C10-115-B	80420 00	85,5	115	27	75	4,07	0,187
C11-50M12-B	80402 00	M12	50	15	400	0,91	0,055
C11-65M16-B	80404 00	M16	65	15	200	1,51	0,090
C11-80M20-B	80406 00	M20	80	15	200	2,29	0,130
C11-95M24-B	80408 00	M24	95	15	150	3,04	0,173
C11-115M24-B	80410 00	M24	115	15	75	4,64	0,253

Prices quoted are exclusive of VAT / Ceny sú uvedené bez DPH

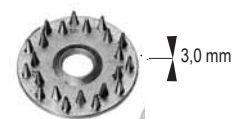

C11



C10

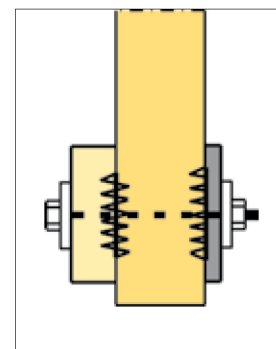

It. no. NEW č. pol. NOVÉ	It. no. OLD č. pol. STARÉ	Dimensions/ Rozměry [mm]				pcs. / package ks./bal.	€ / pcs. € / ks	kg / pcs. kg/ks.
		A	B	T	Ø			
US40/40/10G-B	07001 00	40	40	10	13,5	50	2,21	0,125
US40/50/10G-B	07002 00	40	50	10	13,5x25	50	2,59	0,157
US50/50/8G-B	07003 00	50	50	8	18	50	2,59	0,157
US60/60/6G-B	07006 00	60	60	6	14	50	2,62	0,125

Prices quoted are exclusive of VAT / Ceny sú uvedené bez DPH

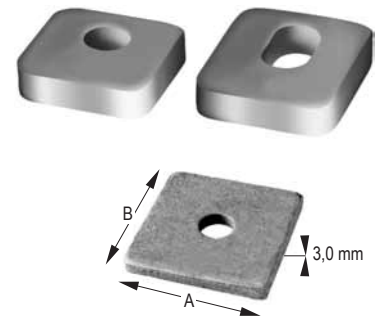

It. no. NEW č. pol. NOVÉ	It. no. OLD č. pol. STARÉ I	Dimensions/ Rozměry [mm]	€ / pcs. € / ks	pcs. / package ks./bal.	kg / pcs. kg/ks.
KOLC1	85000 00	Kolibrodd Skin 1 / Ø50	1,27	300	0,027
KOLC2	85001 00	Kolibrodd Skin 2 / Ø62	1,41	300	0,042
KOLC3	85002 00	Kolibrodd Sin 3 / Ø75	1,71	150	0,060
KOLC4	85003 00	Kolibrodd Skin 4 / Ø95	2,48	100	0,095
KOLC8	85005 00	Kolibrodd Skin 8 / 50x65	1,32	300	0,035
KOLV1	85006 00	Kolibrodd 1/ Ø50 Lose	0,64	200	0,019
KOLV2	85007 00	Kolibrodd 2/ Ø62 Lose	0,75	100	0,034
KOLV8	85011 00	Kolibrodd 8/50x65, Lose	0,68	100	0,033

Prices quoted are exclusive of VAT / Ceny sú uvedené bez DPH

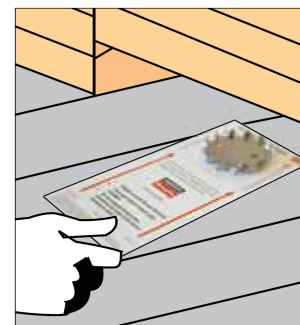



SIMPSON

Strong-Tie

®

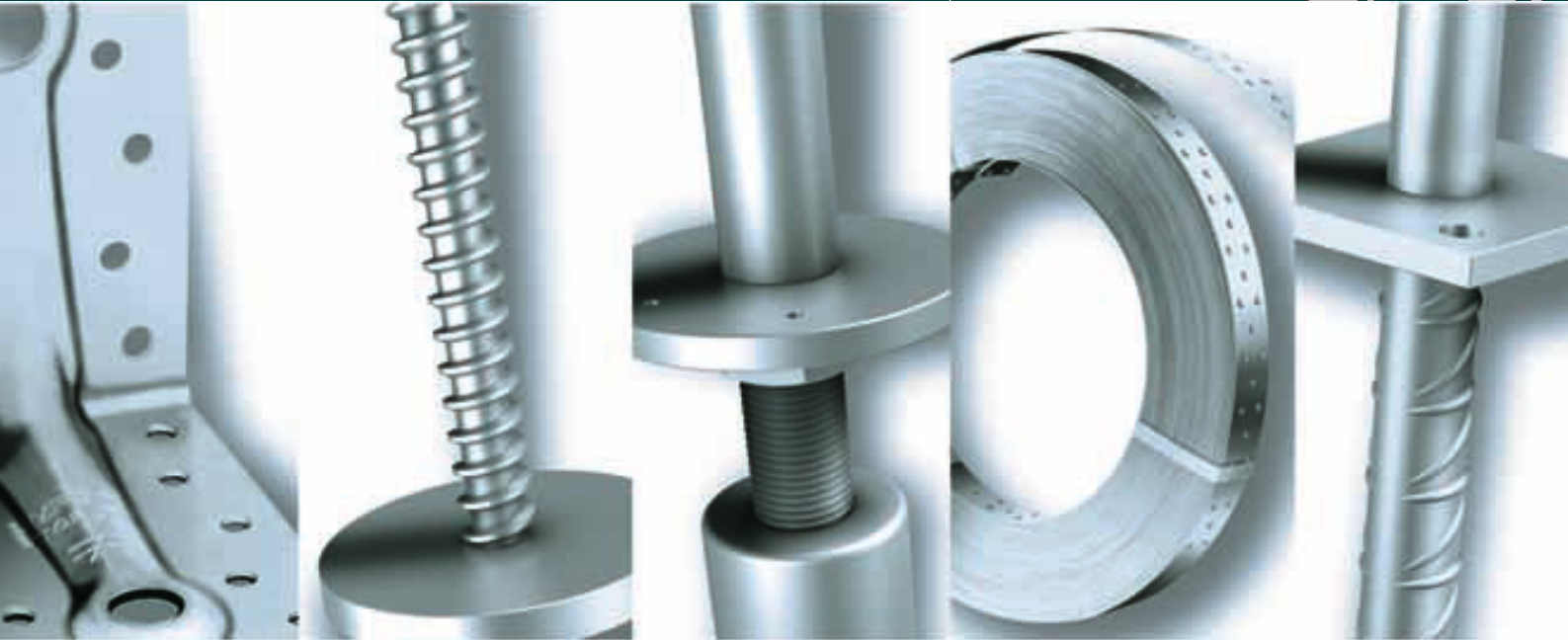

MEE 2012/2013

SIMPSON STRONG-TIE®

5956 W. Las Positas Blvd
Pleasanton, CA 94588

U.S.A.

Tel.: +1 925 560 9000

Fax: +1 925 833 1496

web@strongtie.com

www.strongtie.com

PRODUCTION AND WARHOUSE / VÝROBA
A SKLAD

DÁNEMARK

Simpson Strong-Tie A/S
Boulstrup
DK-8300 Odder
Tel.: +45 87 81 74 00
Fax: +45 87 81 74 09
info@simpsonstrongtie.dk
www.simpsonstrongtie.dk

FRANKREICH

Simpson Strong-Tie
Zac des Quatre Chemins
F-85400 Sainte Gemme La Plaine
Tel.: +33 2 51 28 44 00
Fax: +33 2 51 28 44 01
commercial@strongtie.com
www.strongtie.eu

ENGLAND

Simpson Strong-Tie
Winchester Road – Cardinal Point
UK-Tamworth, Staffordshire B78 3HG
Tel.: +44 1827 255 600
Fax: +44 1827 255 616
web-uk@strongtie.com
www.strongtie.eu

WAREHOUSE / SKLAD

DEUTSCHLAND

Simpson Strong-Tie® GmbH
Riederhofstraße 27
D-60314 Frankfurt
Tel.: +49 69 67 737 89 0
Fax: +49 69 67 737 89 69
info@strongtie.de
www.strongtie.eu
www.strongtie.de

POLEN

Simpson Strong-Tie Sp. Z. o. o.
PL-01-918 Warszawa
Tel./Fax: +48 22 865 22 00
info@simpsonstrongtie.pl
www.simpsonstrongtie.pl

SCHOTTLAND

Simpson Strong-Tie
Unit 6 Macintosh Road
Kirkton Campus, Livingstone EH54 7BW
Tel.: +44 1827 255600
Fax: +44 1827 255616
www.strongtie.co.uk

SCHWEIZ

(Verkauf und Beratung)
Simpson Strong-Tie
Bohnletweg 3
CH-5024 Küttigen
Tel.: +41 62 827 36 77
Fax: +41 62 827 43 05
info@simpsonstrongtie.ch

ČESKÁ REPUBLIKA

Simpson Strong-Tie s.r.o.
Kyjovská 3280
CZ-580 01 Havlíčkův Brod
Česká Republika
Tel.: +420 569 433 555
Fax: +420 569 433 561
www@strongtie.cz
www.strongtie.eu